

# DPG210

## DIGITAL PRESSURE GAUGE



INSTRUCTION  
SHEET

**M5718/1118**

Shop online at [omega.com](http://omega.com) e-mail: [info@omega.com](mailto:info@omega.com)  
For latest product manuals: [www.omegamanual.info](http://www.omegamanual.info)

---

### DESCRIPTION

This gauge features a large 55x55 mm LCD screen with main and auxiliary displays. It displays the pressure in real time and can also display the temperature and the maximum and minimum values of the pressure data.

Powerful functions include 10 common preset pressure units, an adjustable acquisition rate for pressure data, and power supplied by three AA batteries or an external USB connection.

When the gauge is powered by three AA batteries, with the ultra-low power consumption design, the highest service life may exceed 3600 hours.

The gauge features a high precision ADC and high-speed microprocessor in an all-digital design. The gauge provides high precision, good stability and good shock resistance.

- \* 5-digit display with main and auxiliary screen design
- \* AA batter power, service life of more than 3600 hours
- \* High accuracy classes: 0.2/0.1/0.05%FS
- \* 10 available pressure units: MPa, kPa, psi, bar, Pa, mBAR, mmHg, mH<sub>2</sub>O, Torr, kgf/cm<sup>2</sup>
- \* Display of temperature, maximum and minimum values of the pressure data

### NOTICE

1. Please check the packaging and appearance after you received the product.
2. Please check the mode and specification of the product. Ensure correct electrical connection and mounting method.
3. Power: three AA battery or USB-power.
4. During use, please note the technical and operation conditions: the temperature of medium, burst pressure, power supply.
5. This product is a precision device, DO NOT use hard objects to touch the diaphragm or disassemble.
6. During installation, do not install or uninstall with excessive forces, take special care with the installation of thread.
7. Please install or uninstall with a suitable wrench.
8. After starting the gauge, it is a normal phenomenon to take a few minutes to stabilize and work normally.
9. During installation, the gauge may be affected by installation stress. After installation, please clear zero with no pressure applied.

(!)Product damage caused by non-professional operation according to the operation instructions is not within the scope of the warranty.

# LCD AND CODE DESCRIPTION

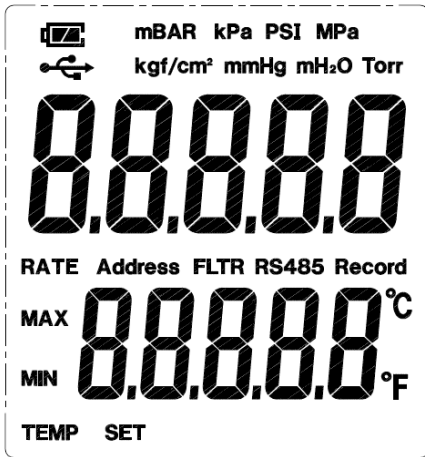

CODE	DESCRIPTION
MPA PSI mBAR kgf/cm <sup>2</sup> kPa mmHg mH <sub>2</sub> O Torr	PRESSURE UNIT
MAX/MIN	MAX/MIN PRESSURE
RATE	SAMPLING RATE
TEMP	CURRENT TEMPERATURE
°C	CENTIGRADE
°F	FAHRENHEIT DEGREE
TIME	TIME
SET	SET FUNCTION
	BATTERY LEVEL
Rs485	Rs485 SIGNAL
Address	ADDRESS BIT
FLTR	BAUD RATE
Record	RECORD FUNCTION
	COMMUNICATION SIGN

## BUTTON FUNCTION

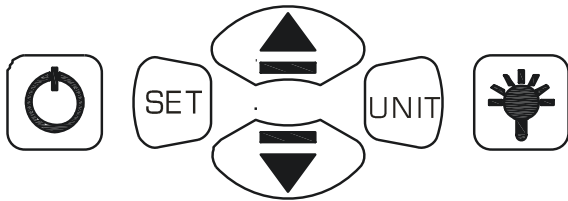

BUTTON	NAME	DESCRIPTION
	POWER	Short press to turn ON/OFF
	SET	Short press two seconds to enter set function, the 'SET' light on.
	INCREASE	Short press to increase; long press to zero clearing
	DECREASE	Short press to decrease; long press to clear auxiliary screen record value
	UNIT	Short press to switch pressure units
	BACKLIGHT	Short press to turn on the backlight; long press to keep the backlight on

## APPEARANCE

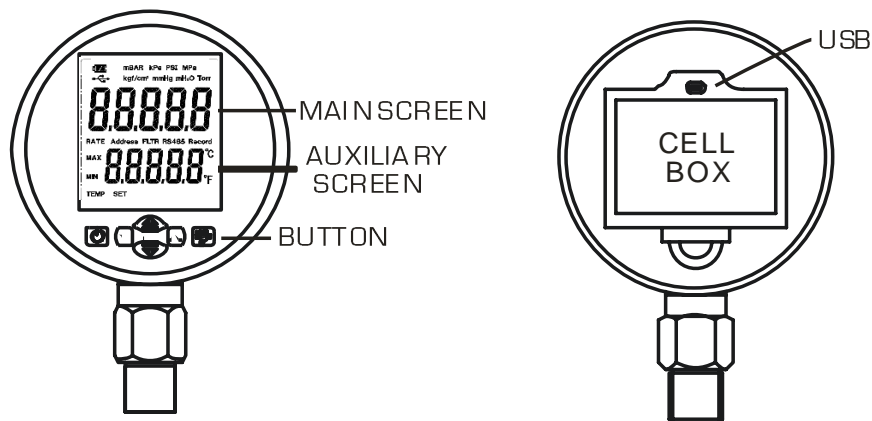

## POWER

Two modes power: Battery or USB

BATTERY	Three AA battery
USB	USB2.0, 5V Power(5V 0.15A)

## PRODUCT SIZE

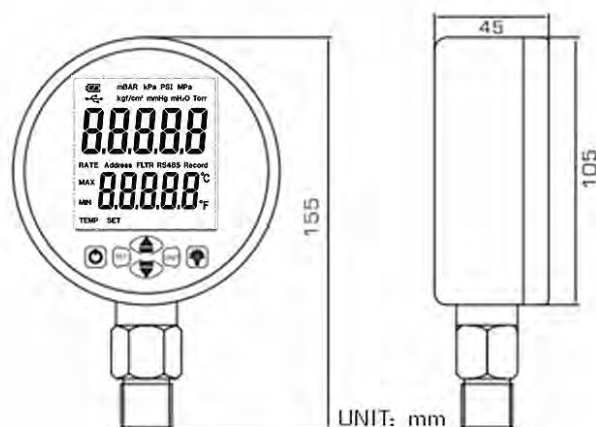

## FUNCTION DESCRIPTION

### 1. ZERO CLEARING

Long press '▲' for 4 seconds to zero clearing (main screen). The full screen displayed once means zero-clearing finished.

\*\*\* MAIN SCREEN ZERO CLEARING MUST BE WITHOUT PRESSURE.

### 2. MAX/MIN VALUE ZERO CLEARING

Long press '▼' for 4 seconds to Max/Min value zero-clearing (auxiliary screen). The full screen displayed once means zero-clearing finished.

### 3. PRESSURE UNITS SWITCH

Short press 'UNIT' to switch units cyclically.

\*\*\* NOT ALL THE PRESSURE UNITS CAN BE SWITCHED. THE SPECIFIC SITUATION BASED ON PRESSURE RANGE CHOICE.

### 4. BACK-LIGHT

Short press '💡', the back-light will be on for 3 seconds; Long press '💡' for 2 seconds, the back-light will be always on. Press '💡' to turn off.

### 5. ON/OFF

Short press '🔌' to turn on/off the gauge.









### 6. AUTOMATIC SHUTDOWN

When the function is on, the gauge will shut down automatically with any operation in 10 minutes.

\*\*\* Factory defaults the function is on. Turn off the function, please refer to 'FUNCTION SETTING'.

## FUNCTION SETTING

\*\*\* Press 'SET' button for 2 seconds to enter set function, the screen will show 'SET' sign.

CODE	FUNCTION	DESCRIPTION
RATE	Sampling Rate	When 'RATE' light is on, the value showing on the auxiliary screen is sampling rate. The sampling rate range is 1~10(Factory defaults: 3). Higher value means lower sampling rate and stable; smaller value means faster sampling rate. then press 'SET' button to enter next function setting.
MAX	Maximun Value	When 'MAX' light is on, auxiliary screen showing 'OFF' means the function is off. If it is showing 'ON' means the function is on. Press '  ' or '  ' or '  ' or '  ' or '  ' or '  ' or '  ' or '  <h2>PROBLEMS AND SOLUTION</h2>

1. Q: Back-light Dim  
A : Low Battery, install new battery.
2. Q: Battery identification flashing.  
A : Low Battery, install new battery.
3. Q: Pressure no change  
A: Reason Analysis:  
(1). Pressure port is block.  
(2). Zero clearing with pressure applied.  
(3). Pressure sensor damage.

Solutions:

- (1). Clear pressure connector.
- (2). Zero clearing without pressure.
- (3). Return factory for repair.

4. Q: Showing 'E-H'

A: Reason Analysis:

- (1). Over pressure
- (2). Pressure sensor is damaged

Solutions:

- (1). Decrease pressure
- (2). Return factory for repair

5. Q: Pressure change slowly

A: Sampling rate low. Sampling rate value decrease

6. Q: Pressure change slowly

A: Value is beating too fast. Sampling rate value increase

## **WARNING**

1. This product is a precision instrument, it should be regularly calibrated to ensure the accuracy of the product.
2. Product storage should be free moisture and dust.
3. The company reserves the right to change the specifications of the product without notice.



omega.com info@omega.com

## Servicing North America:

### U.S.A. Headquarters:

Omega Engineering, Inc.  
Toll-Free: 1-800-826-6342 (USA & Canada only)  
Customer Service: 1-800-622-2378 (USA & Canada only)  
Engineering Service: 1-800-872-9436 (USA & Canada only)  
Tel: (203) 359-1660 Fax: (203) 359-7700  
e-mail: info@omega.com

**For Other Locations Visit [omega.com/worldwide](http://omega.com/worldwide)**

---

The information contained in this document is believed to be correct, but OMEGA accepts no liability for any errors it contains, and reserves the right to alter specifications without notice.

---

## WARRANTY/DISCLAIMER

OMEGA ENGINEERING, INC. warrants this unit to be free of defects in materials and workmanship for a period of **13 months** from date of purchase. **OMEGA's WARRANTY** adds an additional one (1) month grace period to the normal **one (1) year product warranty** to cover handling and shipping time. This ensures that **OMEGA's** customers receive maximum coverage on each product.

If the unit malfunctions, it must be returned to the factory for evaluation. **OMEGA's** Customer Service Department will issue an Authorized Return (AR) number immediately upon phone or written request. Upon examination by OMEGA, if the unit is found to be defective, it will be repaired or replaced at no charge. **OMEGA's WARRANTY** does not apply to defects resulting from any action of the purchaser, including but not limited to mishandling, improper interfacing, operation outside of design limits, improper repair, or unauthorized modification. This **WARRANTY** is VOID if the unit shows evidence of having been tampered with or shows evidence of having been damaged as a result of excessive corrosion; or current, heat, moisture or vibration; improper specification; misapplication; misuse or other operating conditions outside of **OMEGA's** control. Components in which wear is not warranted, include but are not limited to contact points, fuses, and triacs.

**OMEGA is pleased to offer suggestions on the use of its various products. However, OMEGA neither assumes responsibility for any omissions or errors nor assumes liability for any damages that result from the use of its products in accordance with information provided by OMEGA, either verbal or written. OMEGA warrants only that the parts manufactured by the company will be as specified and free of defects. OMEGA MAKES NO OTHER WARRANTIES OR REPRESENTATIONS OF ANY KIND WHATSOEVER, EXPRESSED OR IMPLIED, EXCEPT THAT OF TITLE, AND ALL IMPLIED WARRANTIES INCLUDING ANY WARRANTY OF MERCHANTABILITY AND FITNESS FOR A PARTICULAR PURPOSE ARE HEREBY DISCLAIMED. LIMITATION OF LIABILITY: The remedies of purchaser set forth herein are exclusive, and the total liability of OMEGA with respect to this order, whether based on contract, warranty, negligence, indemnification, strict liability or otherwise, shall not exceed the purchase price of the component upon which liability is based. In no event shall OMEGA be liable for consequential, incidental or special damages.**

CONDITIONS: Equipment sold by OMEGA is not intended to be used, nor shall it be used: (1) as a "Basic Component" under 10 CFR 21 (NRC), used in or with any nuclear installation or activity; or (2) in medical applications or used on humans. Should any Product(s) be used in or with any nuclear installation or activity, medical application, used on humans, or misused in any way, OMEGA assumes no responsibility as set forth in our basic **WARRANTY / DISCLAIMER** language, and, additionally, purchaser will indemnify OMEGA and hold OMEGA harmless from any liability or damage whatsoever arising out of the use of the Product(s) in such a manner.

## RETURN REQUESTS / INQUIRIES

Direct all warranty and repair requests/inquiries to the OMEGA Customer Service Department. **BEFORE RETURNING ANY PRODUCT(S) TO OMEGA, PURCHASER MUST OBTAIN AN AUTHORIZED RETURN (AR) NUMBER FROM OMEGA'S CUSTOMER SERVICE DEPARTMENT (IN ORDER TO AVOID PROCESSING DELAYS).** The assigned AR number should then be marked on the outside of the return package and on any correspondence.

The purchaser is responsible for shipping charges, freight, insurance and proper packaging to prevent breakage in transit.

FOR **WARRANTY** RETURNS, please have the following information available BEFORE contacting OMEGA:

1. Purchase Order number under which the product was PURCHASED,
2. Model and serial number of the product under warranty, and
3. Repair instructions and/or specific problems relative to the product.

FOR **NON-WARRANTY** REPAIRS, consult OMEGA for current repair charges. Have the following information available BEFORE contacting OMEGA:

1. Purchase Order number to cover the COST of the repair,
2. Model and serial number of the product, and
3. Repair instructions and/or specific problems relative to the product.

OMEGA's policy is to make running changes, not model changes, whenever an improvement is possible. This affords our customers the latest in technology and engineering. OMEGA is a trademark of OMEGA ENGINEERING, INC.

© Copyright 2018 OMEGA ENGINEERING, INC. All rights reserved. This document may not be copied, photocopied, reproduced, translated, or reduced to any electronic medium or machine-readable form, in whole or in part, without the prior written consent of OMEGA ENGINEERING, INC.