

omega.com®
ΩOMEGA™

OMEGAnet® Online Service
www.omega.com

Internet e-mail
info@omega.com

Servicing North America:

USA:
ISO 9001 Certified

One Omega Drive, Box 4047
Stamford CT 06407-0047

FAX: (203) 359-7700

Tel: (203) 359-1660
e-mail: info@omega.com

Canada:

976 Bergar
Laval (Quebec) H7L 5A1, Canada

FAX: (514) 856-6886

Tel: (514) 856-6928
e-mail: info@omega.ca

For immediate technical or application assistance:

USA and Canada: Sales Service: 1-800-826-6342 / 1-800-TC-OMEGA®
Customer Service: 1-800-622-2378 / 1-800-622-BEST®
TELEPHONE SERVICE: 1-800-872-9436 / 1-800-USA-WHEN®
TELEX: 996404 EASYLINK; 62968934 CABLE: OMEGA

Mexico: En Español (001) 203-359-7803 e-mail: espanol@omega.com
FAX: (001) 203-359-7802 info@omega.com.mx

Servicing Europe:

Postbus 8034, 1180 LA Amstelveen, The Netherlands
Tel: +31 (0)20 347211 FAX: +31 (0)20 6434643
Toll Free in Benelux: 0800 0993344

Czech Republic:

Fryštatska 194, 733 01 Karvíná, Czech Republic
Tel: +420 (0)39 633189 FAX: +420 (0)59 6311114
Toll Free: 0800-1-66342 e-mail: info@omegashop.cz

France:

11, rue Jacques Cartier, 78280 Guyancourt, France
Tel: +33 (0)1 61 37 2900 FAX: +33 (0)1 30 57 5427
Toll Free in France: 0800 466 342

Germany/Austria:

Daimlerstrasse 26, D-75392 Deckenpfronn, Germany
Tel: +49 (0)7056 9398-0 FAX: +49 (0)7056 9398-29
Toll Free in Germany: 0800 639 7676
e-mail: info@omega.de

United Kingdom:

ISO 9002 Certified
One Omega Drive, River Bend Technology Centre
Northbank, Irlam, Manchester
M44 5BD United Kingdom
Tel: +44 (0)161 777 6611 FAX: +44 (0)161 777 6622
Toll Free in United Kingdom: 0800-488-488
e-mail: sales@omega.co.uk

1 YEAR
WARRANTY

MADE IN
USA



NIST



User's Guide

It is the policy of OMEGA to comply with all worldwide safety and EMC/EMI regulations that apply. OMEGA is constantly pursuing certification of its products to the European New Approach Directives. OMEGA will add the CE mark to every appropriate device upon certification. The information contained in this document is believed to be correct but OMEGA Engineering, Inc. accepts no liability for any errors it contains, and reserves the right to alter specifications without notice. **WARNING:** These products are not designed for use in, and should not be used for, human applications.

WARRANTY/DISCLAIMER

OMEGA ENGINEERING, INC. warrants this unit to be free of defects in materials and workmanship for a period of **13 months** from date of purchase. OMEGA's WARRANTY adds an additional one (1) month grace period to the normal **one (1) year product warranty** to cover handling and shipping time. This ensures that OMEGA's customers receive maximum coverage on each product.

If the unit malfunctions, it must be returned to the factory for evaluation. OMEGA's Customer Service Department will issue an Authorized Return (AR) number immediately upon phone or written request. Upon examination by OMEGA, if the unit is found to be defective, it will be repaired or replaced at no charge. OMEGA'S WARRANTY does not apply to defects resulting from any action of the purchaser, including but not limited to mishandling, improper interfacing, operation outside of design limits, improper repair, or unauthorized modification. This WARRANTY is VOID if the unit shows evidence of having been tampered with or shows evidence of damage as a result of excessive corrosion; or current, heat, moisture or vibration; improper specification; misapplication; misuse or other operating conditions outside of OMEGA's control. Components which wear are not warranted, including but not limited to contact points, fuses, and triacs.

OMEGA is pleased to offer suggestions on the use of its various products. However, OMEGA neither assumes responsibility for any omissions or errors nor assumes liability for any damages that result from the use of its products in accordance with information provided by OMEGA, either verbal or written. OMEGA warrants only that the parts manufactured by it will be as specified and free of defects. OMEGA MAKES NO OTHER WARRANTIES OR REPRESENTATIONS OF ANY KIND WHATSOEVER, EXPRESS OR IMPLIED, EXCEPT THAT OF TITLE, AND ALL IMPLIED WARRANTIES INCLUDING ANY WARRANTY OF MERCHANTABILITY AND FITNESS FOR A PARTICULAR PURPOSE ARE HEREBY DISCLAIMED. LIMITATION OF LIABILITY: The remedies of purchaser set forth herein are exclusive, and the total liability of OMEGA with respect to this order, whether based on contract, warranty, negligence, indemnification, strict liability or otherwise, shall not exceed the purchase price of the component upon which liability is based. In no event shall OMEGA be liable for consequential, incidental or special damages.

CONDITIONS: Equipment sold by OMEGA is not intended to be used, nor shall it be used: (1) as a "Basic Component" under 10 CFR 21 (NRC), used in or with any nuclear installation or activity; or (2) in medical applications or used on humans. Should any products be used in or with any nuclear installation or activity, medical application, used on humans, or misused in any way, OMEGA assumes no responsibility as set forth in our basic WARRANTY/DISCLAIMER language, and, additionally, purchaser will indemnify OMEGA and hold OMEGA harmless from any liability or damage whatsoever arising out of the use of the Product(s) in such a manner.

RETURN REQUESTS / INQUIRIES

Direct all warranty and repair requests/inquiries to the OMEGA Customer Service Department. BEFORE RETURNING ANY PRODUCT(S) TO OMEGA, PURCHASER MUST OBTAIN AND RETURN (AR) NUMBER FROM OMEGA'S CUSTOMER SERVICE DEPARTMENT (IN ORDER TO AVOID PROCESSING DELAYS). The assigned AR number should then be marked on the outside of the return package and on any correspondence.

The purchaser is responsible for shipping charges, freight, insurance and proper packaging to prevent breakage in transit.

PATENT NOTICE: U. S. Pat. No. 6,074,089; 5,465,838 / Canada 2,228,333; 2,116,055 / UK GB 2,321,712 / Holland 1008153 / Israel 123052 / France 2 762 908 / EPO 0614194. Other patents pending.

FOR WARRANTY RETURNS, please have the following information available BEFORE contacting OMEGA:

1. Purchase Order number under which the product was PURCHASED.
2. Model and serial number of the product under warranty, and
3. Repair instructions and/or specific problems relative to the product.

OMEGA's policy is to make running changes, not model changes, whenever an improvement is possible. This affords our customers the latest in technology and engineering.

OMEGA is a registered trademark of OMEGA ENGINEERING, INC.

© Copyright 2004 OMEGA ENGINEERING, INC. All rights reserved. This document may not be copied, photocopied, reproduced, translated, or reduced to any electronic medium or machine-readable form, in whole or in part, without the prior written consent of OMEGA ENGINEERING, INC.

FOR NON-WARRANTY REPAIRS, consult OMEGA for current repair charges. Have the following information available BEFORE contacting OMEGA:

1. Purchase Order number to cover the COST of the repair.
2. Model and serial number of the product, and
3. Repair instructions and/or specific problems relative to the product.



Shop online at

omega.com®
ΩOMEGA™

omega.com

e-mail: info@omega.com

For latest product manuals:

omegamannual.info

ISO 9001
CERTIFIED
CORPORATE QUALITY
STAMFORD, CT

ISO 9002
CERTIFIED
CORPORATE QUALITY
MANCHESTER, UK

HHT13

Pocket Laser Tachometer with Remote Sensor Input

M4151/0507

SAFEGUARDS AND PRECAUTIONS



WARNING - This product emits a visible beam of laser light. Avoid exposure to the laser radiation. The use of optical viewing aids (binoculars, for example) may increase the ocular hazard.

CAUTION - The laser beam should not be intentionally aimed at people or animals.

CAUTION - Use of controls or adjustments or performance of procedures other than those specified herein may result in hazardous radiation exposure.



Read and follow all instructions in this manual carefully, and retain this manual for future reference.

Do not use this instrument in any manner inconsistent with these operating instructions or under any conditions that exceed the environmental specifications stated.

This instrument is not user serviceable. For technical assistance, contact the sales organization from which you purchased the product.



In order to comply with EU Directive 2002/96/EC on Waste Electrical and Electronic Equipment (WEEE): This product may contain material which could be hazardous to human health and the environment. DO NOT DISPOSE of this product as unsorted municipal waste. This product needs to be RECYCLED in accordance with local regulations, contact your local authorities for more information. This product may be returnable to your distributor for recycling - contact the distributor for details.

14.0 OPTIONS / ACCESSORIES

- | | |
|----------------------|---|
| HHT-RT-5 | Reflective Tape, 5 foot [1.5 m] roll, ½ inch [13 mm] wide |
| HHT13-RCA | Remote Contact Assembly with 10 cm wheel, concave and convex tips |
| HHT13-CTE | Concave/convex contact tips and 10 cm linear contact wheel |
| HHT13-LCW | 12 inch circumference wheel for use with HHT13-RCA |
| HHT20-ROS | Remote Optical Sensor |
| HHT-ROS-CABLE | 25 foot extension cable for all sensors |
| HHT13-CC10 | Padded Nylon Carrying Case |

12.0 BATTERIES

When displayed, replace batteries.



Remove battery cover

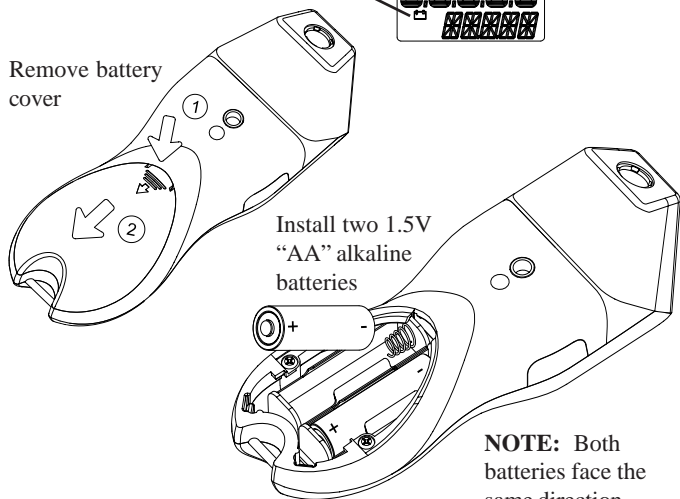

Install two 1.5V
"AA" alkaline
batteries

NOTE: Both
batteries face the
same direction.

13.0 CLEANING

To clean the instrument, wipe with a damp cloth using mild soapy solution.

TABLE OF CONTENTS

1.0	OVERVIEW	1
2.0	FEATURE LOCATIONS	1
3.0	LCD DISPLAY SYMBOLS	2
4.0	HHT13 SPECIFICATIONS	3
5.0	PREPARATION FOR MEASUREMENT	7
5.1	Non-Contact Preparation	7
5.2	Direct Contact Preparation	7
5.3	Connecting External Sensors	8
6.0	TACHometer Mode	9
6.1	TACHometer Setup	9
6.2	TACHometer Operation	11
7.0	RATE Mode	12
7.1	RATE Setup	12
7.2	RATE Operation	14
8.0	TOTALizer Mode	15
8.1	TOTALizer Setup	15
8.2	TOTALizer Operation	18
9.0	TIMER Mode	19
9.1	TIMER Setup	19
9.2	TIMER Operation	20
10.0	MAKING MEASUREMENTS	21
10.1	Non-Contact Measurements	21
10.2	Direct Contact Measurements	21
11.0	INPUT/OUTPUT	22
12.0	BATTERIES	23
13.0	CLEANING	23
14.0	OPTIONS/ACCESSORIES	24

1.0 OVERVIEW

The HHT13 is a precision hand-held multifunction Tachometer, Ratemeter, Totalizer and Timer. It is programmable to display directly in Revs, Inches, Feet, Yards, Miles, Centimeters and Meters or function as a stopwatch or interval timer. Input / output sockets allow for remote sensing and pulse output to external indicating devices. For ease of use, the instrument can be "Locked-on" for continuous operation.

2.0 FEATURE LOCATIONS

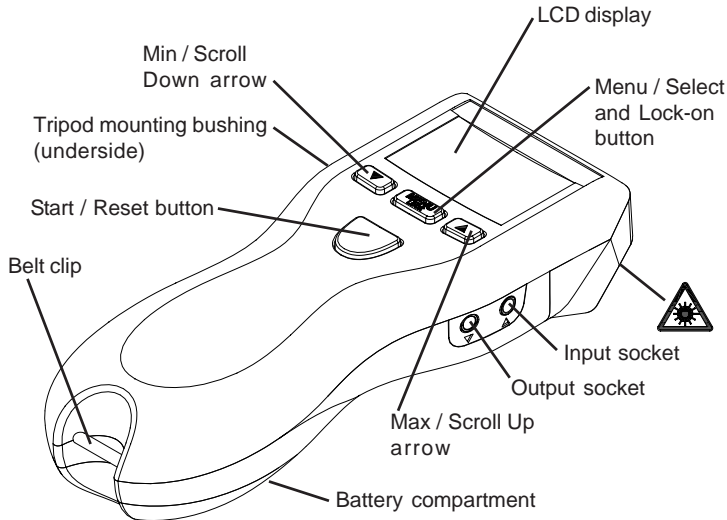

AVOID EXPOSURE - LASER RADIATION IS EMITTED FROM THIS APERTURE

11.0 INPUT / OUTPUT

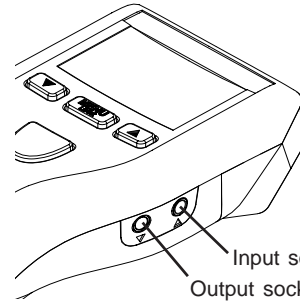

Input: Accepts remote sensor or Remote Contact Assembly (HHT13-RCA). 1/8" (3.5mm) stereo phone plug.

Output: 1 pulse per revolution TTL output on internal operation. Pulse repeater with external sensors. 1/8" (3.5mm) mono phone plug.

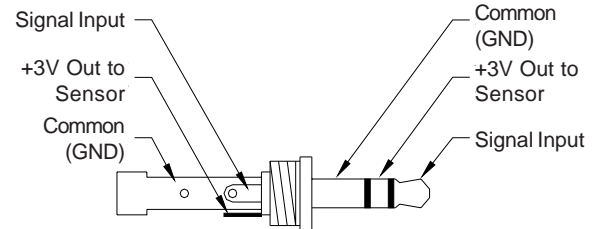

Input Connector Detail (Stereo plug)

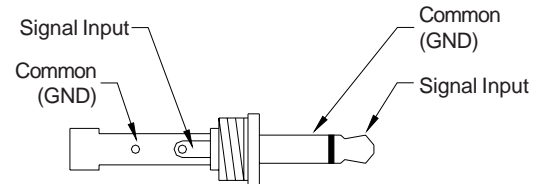

Output Connector Detail (Mono plug)

10.0 MAKING MEASUREMENTS

10.1 Non-Contact Measurements

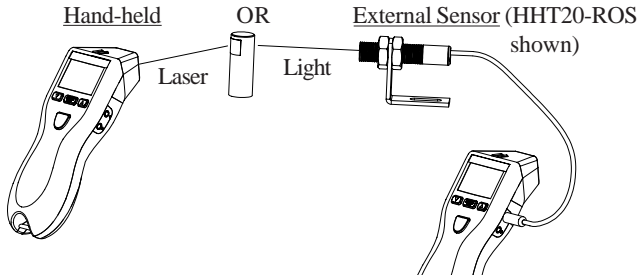

10.2 Direct Contact Measurements

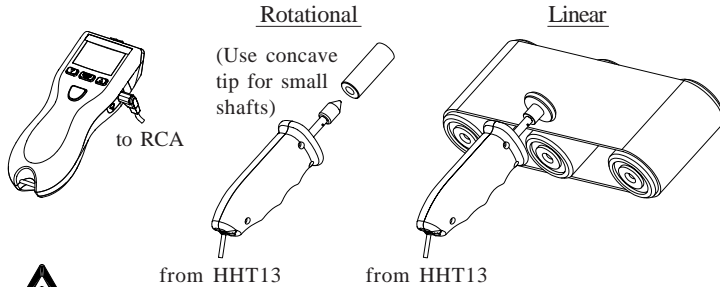

ONLY USE MODERATE PRESSURE

WARNING: Making measurements in direct contact with rotating equipment can be dangerous. Keep all loose clothing and hair away from exposed moving machinery. Keep the hand holding the instrument well behind the back end of the Remote Contact Assembly. Properly replace all machinery guards after completing measurement. Do not use for rotation greater than 20,000 RPM.

3.0 LCD DISPLAY SYMBOLS

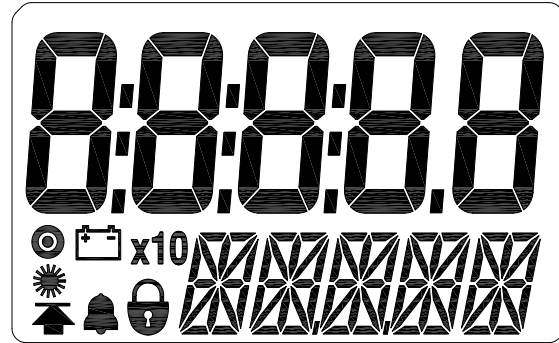

On Target Indicator. Blinks on whenever there is an input signal. Will appear to be solid on at higher frequencies.



Low Battery icon. Indicates that the batteries are low and need to be replaced.



Times Ten icon. Indicates that the value shown is ten times that which is displayed.



Laser Indicator. Red laser is on when this indicator is illuminated.



Lock icon. Indicates that the unit is “Locked” on and making continuous measurements (Lock mode).

4.0 HHT13 SPECIFICATIONS

Laser Specifications:

Classification: Class 2 (per IEC 60825-1 Ed 1.2 2001-8)
Complies with FDA performance standards for laser products except for deviations pursuant to Laser Notice No. 50, dated July 26, 2001.

Maximum Laser Output: 1mW
Pulse Duration: Continuous
Laser Wavelength: 650 nm
Beam Divergence: < 1.5 mrad
Beam Diameter: 4 x 7 mm typical at 2 meters
Laser Diode Life: 8,000 operating hours MTBF (1 year warranty)

Non-Contact Specifications:

Ranges: RPM 5 – 200,000
RPS 0.084 – 3,333.3
RPH 300-999,990

Resolution: Fixed: 1 (10 above 99,999)
Auto-ranging: 0.001 to 1.0 (10 above 99,999)

Accuracy: ±0.01% of reading or resolution limit

Operating Range: up to 25 feet (7.62 m) or up to 70 degrees off perpendicular to reflective tape target

Contact Specifications using optional Remote Contact Assembly:

Range: Contact Tips: 0.5 to 20,000 RPM
10 cm / 12-inch Wheel: 0.5 to 12,000 RPM

Resolution: Fixed: 1 (10 above 99,999)
Auto-ranging: 0.001 to 1.0 (10 above 99,999)

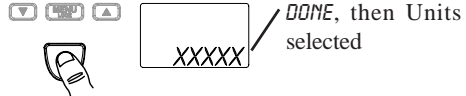
8. Save and advance 
9. Exit Setup – Ready to measure 

Unit will remember these settings (including lock on/off) even if turned off and back on.

9.2 TIMER Operation

Measure:

Manual  Each press toggles Start and Stop



Auto  OR Start and Stop triggered by Remote Optical Sensor (HHT20-ROS)



Reset  With Timer stopped - Resets time to 00:00.0



Lap  With Timer running - Stops at elapsed time to date. To continue, press again.











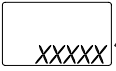

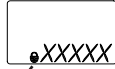

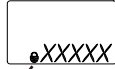



Power Off  OR Automatic after 90 seconds if unit not Locked on



9.0 TIMER Mode

9.1 TIMER Setup

1. Turn Power ON   Last Units selected are displayed
- 1a. To toggle Lock On/Off   Press and Hold   Locked On
2. Enter Setup Mode  
3. Enter selection of Mode   Last Mode selected is displayed
4. Select TIMER Mode  OR  Repeat until *TIMER* displayed
5. Save and advance  
6. Enter selection of Timer function   *MAN* or *AUTO*
7. Select Timer function  OR  Toggles between Manual and Auto

Contact Specifications (continued):

Accuracy: Revs: $\pm 0.05\%$ of reading (RPM) or resolution limit (with no slippage)
 Linear: $\pm 0.5\%$ of reading or resolution limit (with no slippage)

Contact Measurements Ranges:

TACHOMETER:

Revolutions per Minute (RPM) 0.5 to 20,000 RPM
 Revolutions per Second (RPS) 0.0833 to 333.33 RPS
 Revolution per Hour (RPH) 30 to 999,990 RPH

RATES:

Wheel Circumference:

Inches per Second	10 cm: 0.033 to 1312.3 IPS
	12 in: 0.100 to 2,400.0 IPS
Inches per Minute	10 cm: 1.969 to 78,740 IPM
	12 in: 6.000 to 144,000 IPM
Inches per Hour	10 cm: 118.11 to 999,990 IPH
	12 in: 360.00 to 999,990 IPH
Feet per Second	10 cm: 0.003 to 109.36 FT/S
	12 in: 0.009 to 200.00 FT/S
Feet per Minute	10 cm: 0.164 to 6,561.7 FT/M
	12 in: 0.500 to 12,000 FT/M
Feet per Hour	10 cm: 9.843 to 393,700 FT/H
	12 in: 30.000 to 720,000 FT/H
Yards per Second	10 cm: 0.001 to 36.453 YPS
	12 in: 0.003 to 66.667 YPS
Yards per Minute	10 cm: 0.055 to 2,187.2 YPM
	12 in: 0.167 to 4,000.0 YPM

Contact Measurements Ranges (continued):

RATES:	Wheel Circumference:	
Yards per Hour	10cm:	3.281 to 131,233 YPH
	12 in:	10.000 to 240,000 YPH
Miles per Hour	10 cm:	0.002 to 74.564 MPH
	12 in:	0.006 to 136.36 MPH
Centimeters per Second	10 cm:	0.084 to 3,333.3 CM/S
	12 in:	0.21 to 3,048.0 CM/S
Centimeters per Minute	10 cm:	5.000 to 200,000 CM/M
	12 in:	15.240 to 365,760 CM/M
Centimeters per Hour	10 cm:	300.00 to 999,990 CM/H
	12 in:	914.40 to 999,990 CM/H
Meters per Second	10 cm:	0.001 to 33.333 M/SEC
	12 in:	0.003 to 60.960 M/SEC
Meters per Minute	10 cm:	0.050 to 2,000.0 M/MIN
	12 in:	0.153 to 3,657.6 M/MIN
Meters per Hour	10 cm:	3.000 to 120,000 M/H
	12 in:	9.144 to 219,460 M/H

TOTALIZER:

Counts: 0 to 999,999

Scale Totals in Inches, Feet, Yards, Centimeters or Meters

Input: Internal or External optics or linear contact wheel



Timer Specifications:



Minutes:Seconds.Tenths to 99:59.9

Accuracy: ±0.2 second



Resolution: 0.1 second



8.2 TOTALizer Operation

Measure  OR 

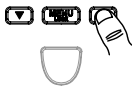
 OR 

Press and hold Lock on

Recall Max or Min   Max or Min Speed (in last selected Tach or Rate mode units)

Recall Time in seconds   Shows time in seconds from when the Start / Reset button is pressed until the last input signal measured.

If unit is Locked on:  Resets Max/Min, Total and Measurement Time

Power Off  OR Automatic after 90 seconds if unit not Locked on

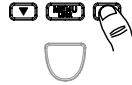
NOTE: Pressing  OR  once before 90 seconds will keep measurements in memory and the display turned on longer.

5.0 PREPARATION FOR MEASUREMENT

5.1 Non-Contact Preparation

For Internal operation (Red laser) or External operation using optional Remote Optical Sensor (ROS-Red LED).

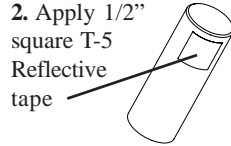

For Small Shafts:

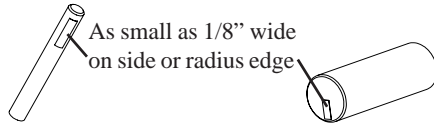

5.2 Direct Contact Preparation

For External operation ONLY using optional Remote Contact Assembly (HHT13-RCA).

Select and install contact option:

1. Contact Tip (Convex tip shown. Use Concave tip for small shafts.)

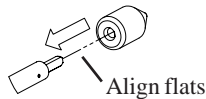

6. Enter selection of Units Different options displayed for Internal or External operation.

Internal or External ROS:

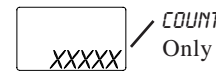

External RCA:

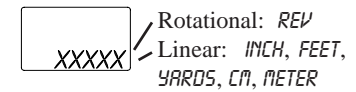

7. Select Units OR Repeat until desired Units displayed

8. Save and advance OR Linear Units

Only for Linear Units:

- 8a. Enter selection of Wheel Last Wheel selected is displayed

- 8b. Select Wheel OR Toggles between 10CM and 12IN

- 8c. Save and Advance

8.0 TOTALizer Mode

8.1 TOTALizer Setup

1. Turn Power ON Different messages displayed for Internal or External operation.



Internal or External ROS:

XXXXXX

Last Units selected

External RCA:

XXXXXX

EXTRN, then scrolling message, then last Units selected

- 1a. To toggle Lock On/Off

Press and Hold



XXXXXX
Locked On

2. Enter Setup Mode



SETUP
MCTIE

3. Enter selection of Mode



XXXXXX

Last Mode selected is displayed

4. Select TOTAL Mode

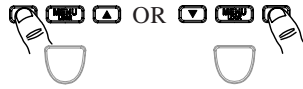

Repeat until TOTAL displayed.

5. Save and advance



SETUP
UNITS

2. 10 cm Wheel

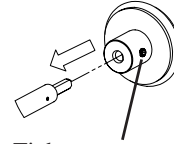

Tighten screw securely into flat on shaft.

OR

3. 12 inch Wheel

Install with pin in shaft fully seated in slot. Tighten screw.

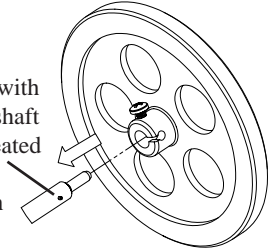

5.3 Connecting External Sensors

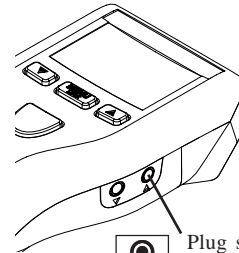

Plug sensor into Input socket



Remote Optical Sensor
(HHT20-ROS)





Remote Contact Assembly
(HHT13-RCA)
(shown with optional 12 inch wheel)

6.0 TACHometer Mode



6.1 TACHometer Setup

1. Turn Power ON
 
 Last Units selected are displayed
- 1a. To toggle Lock On/Off

Press and Hold

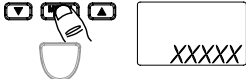

 Locked On
2. Enter Setup Mode
 
3. Enter selection of Mode
 
 Last Mode selected is displayed
4. Select TACH Mode

OR

 Repeat until TACH displayed
5. Save and advance
 
6. Enter selection of Units
 
 RPS, RPM or RPH



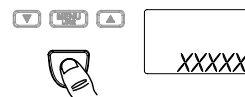

11. Save and advance
 
12. Exit Setup – Ready to measure

DONE, USE CONTACT TIP or [wheel selected], then Units selected









Unit will remember these settings (including lock on/off) even if turned off and back on.

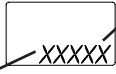







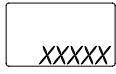

7.2 RATE Operation















- Measure
- OR
- Press and hold
- Lock on
- Recall Max
- Max Speed
- Recall Min
- Min Speed
- If unit Locked on:
- Resets Max/Min
- Power Off
- OR Automatic after 90 seconds if unit not Locked on
- 
- 
- 
- 
- 

RATE Setup (continued):

6. Enter selection of Units   Rotational: *CRPS, CRPM or CRPH*
 Linear: *IPS, IPM, IPH, FT/S, FT/M, FT/H, YPS, YPM, YPH, MPH, CM/S, CM/M, CM/H, M/SEC, M/MIN, M/H*
7. Select Units  OR  Repeat until desired Units displayed 
8. Save and advance   OR 
 Rotational Units Linear Units



















Only for Linear Units:

- 8a. Enter selection of Wheel   Last Wheel selected is displayed
- 8b. Select Wheel  OR  Toggles between 10CM and 12IN 
- 8c. Save and Advance  
9. Enter selection of number of decimal places   NONE, 1, 2 or 3
10. Select decimal places  OR  Repeat until desired decimal places displayed 

7. Select Units  OR  Repeat until desired Units displayed 
8. Save and advance  
9. Enter selection of number of decimal places   NONE, 1, 2 or 3
10. Select decimal places  OR  Repeat until desired decimal places displayed 
11. Save and advance  
12. Exit Setup – Ready to measure   DONE, then Units selected

Unit will remember these settings (including lock on/off) even if turned off and back on.













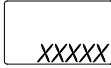

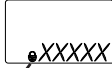

6.2 TACHometer Operation

- Measure  OR   OR 
- Press and hold  Lock on 
- Recall Max     Max Speed
- Recall Min     Min Speed
- If unit Locked on:   Resets Max/Min
- Power OFF    OR Automatic after 90 seconds if unit not Locked on

7.0 RATE Mode

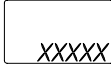
NOTE: External Remote Contact Assembly (HHT13-RCA) must be inserted into input socket.

7.1 RATE Setup

- Turn Power ON    *EXTRN*, then scrolling message, then last Units selected
- To toggle Lock On/Off     Locked On
- Enter Setup Mode   
- Enter selection of Mode    Last Mode selected is displayed
- Select RATE Mode   OR   Toggles between *RATE* and *TOTAL*. Select *RATE*.
- Save and advance 