

# USB In-Line Field Calibratable Signal Conditioner

## For mV Transducers, Free Software Included

**New Cable Assemblies Available**

IN-USBH



All models shown smaller than actual size.

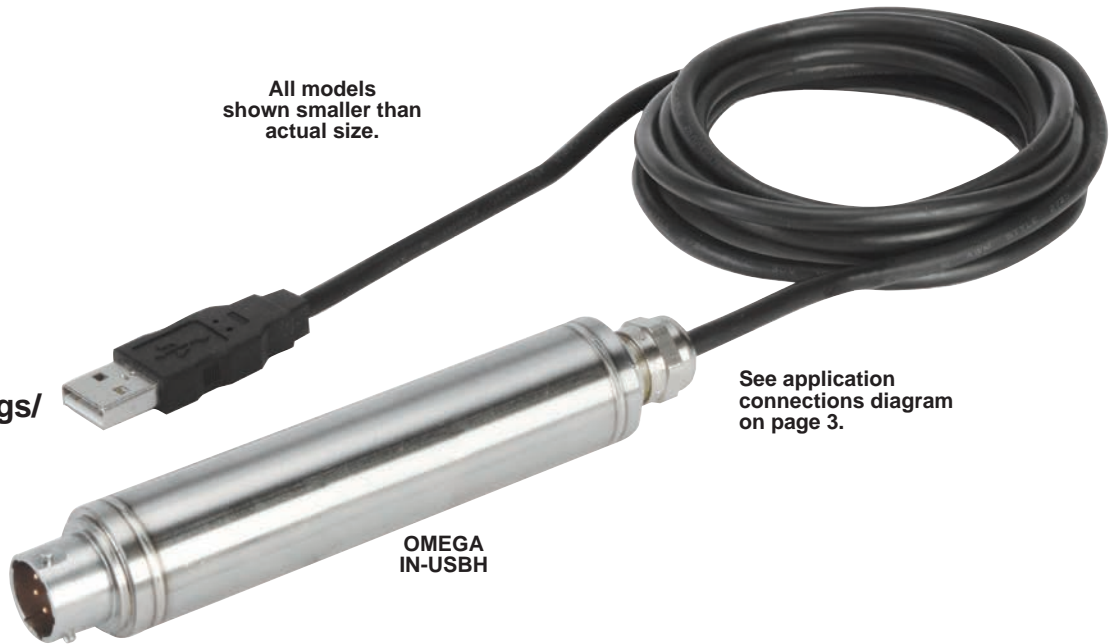

- ✓ High Speed USB Output Option for mV Transducers\*
- ✓ Up to 1000 Readings/Second
- ✓ 316L Stainless Steel Case
- ✓ Stainless Steel Mounting Bracket Included
- ✓ Very Low Thermal and Linearity Errors
- ✓ Excellent Long Term Stability
- ✓ USB 3.0 and Below Compatible
- ✓ Standard USB Connector Cable
- ✓ Factory Calibration with Transducer Available

The IN-USBH field calibratable In-Line Signal Conditioner adds digital USB output to a mV/V pressure or load transducer. Free OMEGA PC software takes the data from the transducer directly to the digital domain, turning your laptop or Windows® tablet (with USB connection) into a virtual meter, chart recorder, and data logger. Export logged data to spreadsheet format for later viewing/analysis.

The PC-connected IN-USBH provides regulated excitation to the transducer, so that no external power supply is used. Sampling rates are adjustable up to 1000 Hz for dynamic or slow moving applications. Mounting bracket is included. Transducer interconnecting cable assemblies can be purchased separately.

The IN-USBH is compatible with mV pressure and load sensors that meet the stated transducer requirements.

See application connections diagram on page 3.

OMEGA IN-USBH

### Specifications

- Resolution:** Up to 5.5 significant figures
- Minimum Isolation:** 2 MΩ @ 50 Vdc case to output terminations
- Thermal Error:** 0.001% FSO/°C
- Linearity Error:** 0.001% FSO
- A to D Conversion:** 24 bit
- Bandwidth:** Up to 1000 updates per second typical (±3%)
- Weight (Typical):** 200 g (7.1 oz) (in-line signal conditioner and USB cable)
- Operating Temperature Range:** -40 to 80°C (-40 to 176°F)
- Connection, IN-USBH (Transducer Side):** PTIH-10-6P 6-pin twist-lock male connector
- Mating Connector (Transducer Side):** PT06F10-6S (sold separately)

- Connection, USB Side:** 2 m (6') USB 2.0 cable
- Transducer Requirements**
- Bridge Sensitivity:** 1 to 400 mV/V
- Bridge Resistance:** 350Ω to 15,000Ω
- Excitation Voltage:** 4.1 Vdc\*
- \* Transducer must be able to function at specified voltage. Virtually all OMEGA mV transducers can operate at 4.1 Vdc.*



Mounting bracket included.

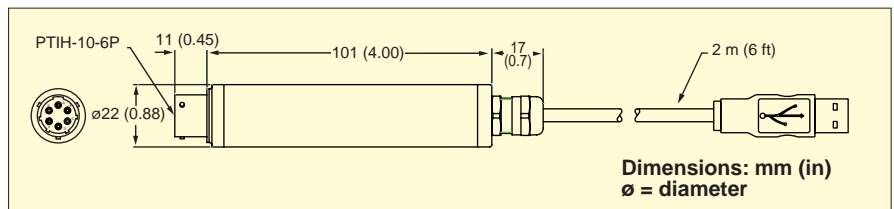

### To Order

Model No.	Description
IN-USBH	Field calibratable USB in-line signal conditioner
PT06F10-6S	Connector used with IN-USBH
CA*INUSBH	Pre-made cable assembly
Contact Sales	Factory or system calibration

Comes complete with mounting bracket and free PC software available for download.

# OMEGA® DIGITAL TRANSDUCER SOFTWARE INCLUDED FREE!

OMEGA's Digital Transducer Software allows you to view, chart and log your data from many Omega Digital transducers (pressure, load, torque, temperature, humidity), all in one place! The new IN-USBH In-Line Signal Conditioner extends USB output and software functionality to almost any mV/V sensor. This software is included FREE with your IN-USBH purchase. Visit us online to download your free copy.

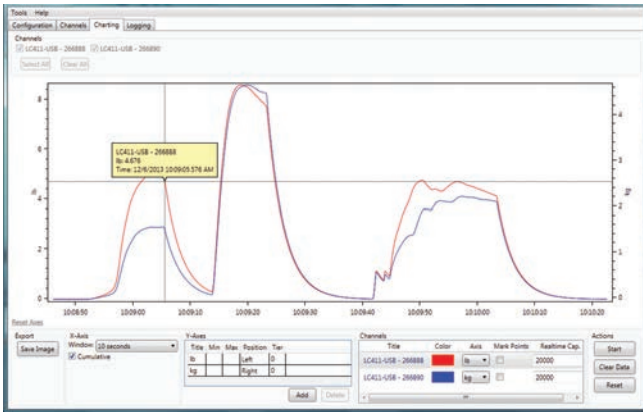

**Charting Window** – The charting window allows you to see your data graphed in real time. The Y axis is configurable to allow simultaneous graphing of multiple engineering units. You can output the image of your data to a .png file.

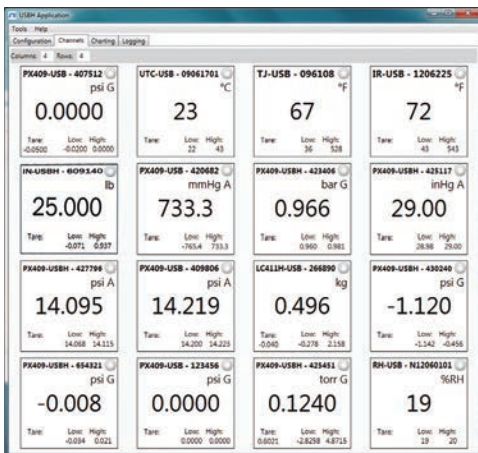

**Channels Window** – Display data from all of your sensors simultaneously. Each channel has configurable user alarms, three data filters, tare, resettable low/high indication, and sample rates ranging from 30 minutes to 1000 Hz.

**Logging Window** – .xlsx filetype output option presents preformatted data for readability. In addition, Live Statistics are displayed, including the sensor information, the start/stop time, the number of samples taken, the current reading, and the High/Low readings. With the logging window, you can capture your data for later analysis.

IN-USBH-609140	
Units	psi
Count	10
Last	14.2349
Low	14.2349
High	14.2353

## CALIBRATION

**Field Calibration** – The IN-USBH can easily be field calibrated with your mV transducer using OMEGA's free software wizard, utilizing known weights or pressures, or the transducer's calibration sheet. See the IN-USBH Quickstart guide for instructions on field calibration.

**Factory Calibration** – The IN-USBH can be calibrated with your mV transducer. Choose Factory System Setup (2 point calibration) or Factory System Calibration (2 point calibration, plus 5 point NIST traceable certificate). Contact Sales for pricing and correct part numbers.

## Example Connection Diagram

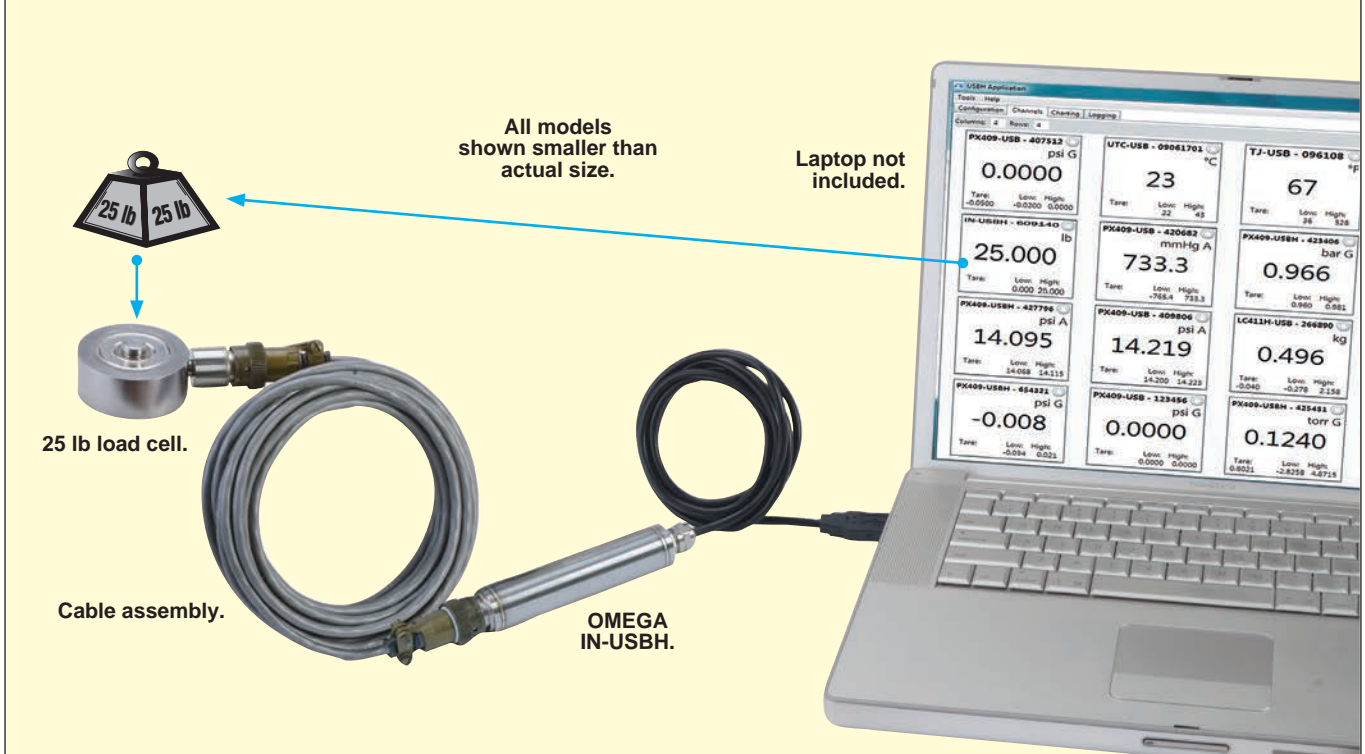

## IN-USBH to Transducer Connection Diagram



**OMEGA strongly recommends the purchase of a ready-made cable assembly to connect the IN-USBH to your transducer, for the following reason:** The IN-USBH excitation sense pins (E and F shown in dashed lines) must be wired to the corresponding transducer excitation pins. Pins E and F create the internal reference that accounts for the cable losses, and if not properly connected, the IN-USBH will not work correctly. For transducers with connectors, solder the +Excitation Sense wire and the +Excitation wire together to the appropriate pin, and the -Excitation Sense wire and the -Excitation wire together to the appropriate pin. For transducers with a cable, use the flying lead version of CA\*USBH, and solder to the end of the transducer cable. For best results, purchase a CA\*INUSBH cable.

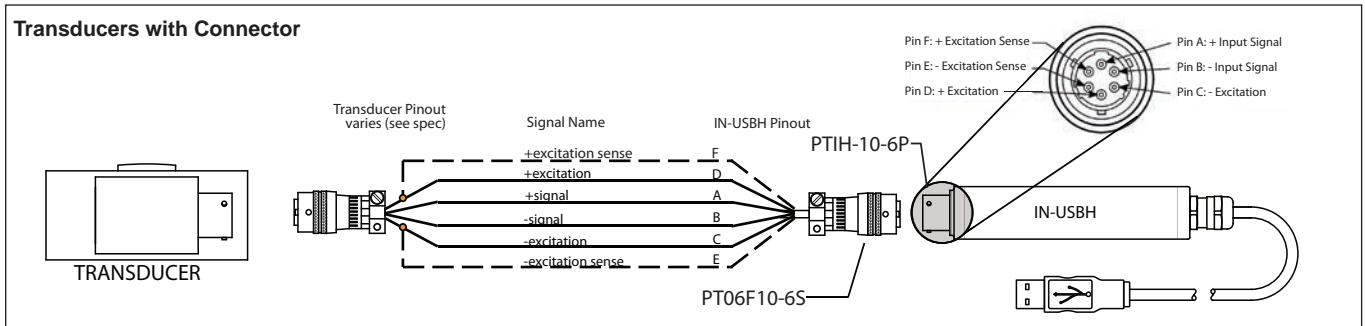

**Transducers with Flying Leads** (signal colors shown for Wiring Code 0 as used in OMEGA's CA-6PC24-0-015-INUSBH or CA-6TE24-0-015-INUSBH):

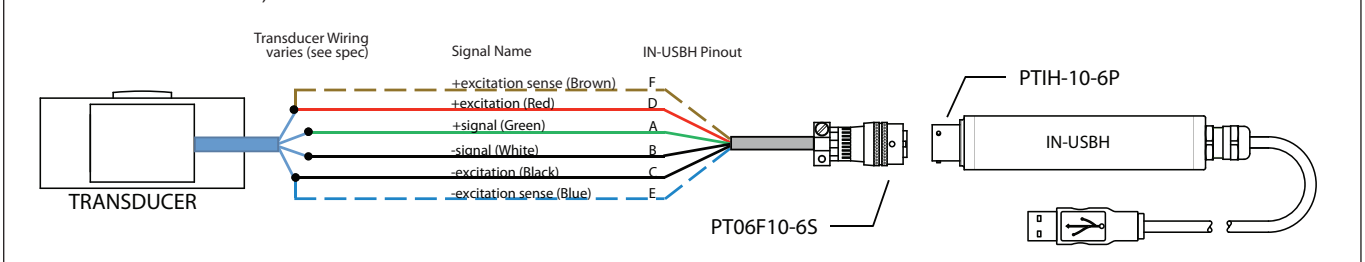

### Please Note: CA\*USBH cable assemblies are:

- Created especially for wiring IN-USBH with OMEGA® transducers
- Have the aforementioned sense wiring already accounted for
- Have a flying lead option for OMEGA® transducers with cables, or non-OMEGA transducers

# Cable Assemblies (CA\*INUSBH)

OMEGA offers a variety of pre-made cable assemblies to interface pressure transducers and load cells with the IN-USBH In-Line USB Signal Conditioner. The standard cable length is 4.6 m (15') but other lengths are also available. All cable assemblies include a 6-pin female twist-lock connector (PT06F10-6S) on the IN-USBH end and twist-lock connector or color-coded stripped wires at the transducer end.

For easy selection, find your OMEGA® transducer model number in the chart below. If it is not listed, use the “Custom Cable Constructor” section below. All transducers with flying leads should use the wiring code 0.

## Standard Cable Part Numbers

Models with Connectors at Both Ends		Wiring Code	Cable Assembly Connectors		Examples of Product Used on (Contact Sales for Products Not Listed)
Model No.	Cable Insulation†		Transducer Side	IN-USBH Side	
CA-6PC24-2A-015-INUSBH	PVC	2A	PT06F8-4S	PT06F10-6S	LC111 25 to 200 lbs
CA-6PC24-3-015-INUSBH	PVC	3	PT06F10-6S	PT06F10-6S	LC1011, LC1112, LC1113, LC411, LC412, LC711, LC712, LC511, LC315, LC213, LC214, LC111 >200 lbs
CA-6TE24-3-015-INUSBH	FEP	3	PT06F10-6S	PT06F10-6S	PX35, PX01, PX02, PX80, PX81
CA-6PC24-4-015-INUSBH	PVC	4	PT06F10-6S	PT06F10-6S	LCHD 5 to 5000 lbs, PX610, PX61V1, PX931
CA-6PC24-4A-015-INUSBH	PVC	4A	MS3106E-14S-6S	PT06F10-6S	LCHD > 5000 lbs
CA-6TE24-5-015-INUSBH	FEP	5	PT06F10-6S	PT06F10-6S	PX32
CA-6TE24-6-015-INUSBH	FEP	6	PT06F10-6S	PT06F10-6S	PX5000, PX5500, PX6000 (mV OUTPUT), PX1004, PX1005
CA-6PC24-8-015-INUSBH	PVC	8	PT06F10-6S	PT06F10-6S	PX329 (mV): ONLY Absolute and ≥150 PSI Gauge
Models with Connector at IN-USBH End, and Flying Leads at Transducer End					
CA-6PC24-0-015-INUSBH	PVC	0	N/A (Flying leads)	PT06F10-6S	Transducers with cable exit
CA-6TE24-0-015-INUSBH	FEP	0	N/A (Flying leads)	PT06F10-6S	Transducers with cable exit

## IN-USBH Wiring Code

PIN	Signal Name
A	+ Signal
B	- Signal
C	- Excitation
D	+ Excitation
E	- Excitation Sense
F	+ Excitation Sense

## OMEGA® Transducer Wiring Codes

PIN	Wiring Code					
	2A	3	4/4A	5	6	8
A	+ Output	+ Output	+ Input	+ Input	+ Input	+ Input
B	- Output	- Output	+ Input	+ Output	+ Output	- Input
C	- Input	- Input	- Input	- Output	- Output	+ Output
D	+ Input	+ Input	- Input	- Input	- Input	- Output
E	-	Shunt**	- Output	Shunt**	-	Spare**
F	-	Shunt**	+ Output	Shunt**	-	Vent**

\*\* Do not connect IN-USBH to this transducer connection. CA\*INUSBH assemblies do not connect to this pin. If a transducer has shunt connections, and if the shunt calibration function is desired, the customer may wire out these connections separately, and connect an external calibration resistor.

## Custom Cable Constructor

For transducers (with 4-or 6-pin twist-lock connector) not listed above (OMEGA or non-OMEGA), modify the grey fields below. Use the “OMEGA® Transducer Wiring Codes” chart to choose the wiring code of your OMEGA® transducer. Choose cable type for your application (PC for PVC, TE for FEP). Choose a length from 1 to 15 feet (15 feet is standard).

## Definition of Cable part number

(grey fields are modifiable)

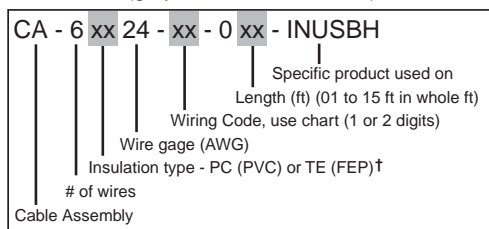

† Insulation Type Temperature Rating: FEP = -55 to 125°C (-67 to 257°F), PVC = -30 to 80°C (-22 to 176°F)  
Cable assembly rated temperature spec may be less than the rated transducer temperature spec.  
Contact Sales for extended and high temperature cable assemblies.

Note: Depending upon the application, lengths longer than 15' may be available. Please Contact Sales for further information.