

Operating Instructions

Picomag IO-Link

Electromagnetic flowmeter



- Make sure the document is stored in a safe place such that it is always available when working on or with the device.
- To avoid danger to individuals or the facility, read the "Basic safety instructions" section carefully, as well as all other safety instructions in the document that are specific to working procedures.
- The manufacturer reserves the right to modify technical data without prior notice. Your Sales Center will supply you with current information and updates to these instructions.

Table of contents

1	About this document	5	8	System integration	20
1.1	Document function	5	8.1	Overview of device description files	20
1.2	Symbols used	5	8.2	Device master file	20
1.2.1	Safety symbols	5	9	Commissioning	21
1.2.2	Electrical symbols	5	9.1	Switching ON the measuring device	21
1.2.3	Communication symbols	5	9.2	Overview of the operating menu	21
1.2.4	Symbols for certain types of information	5	9.3	Configuring the measuring device	21
1.2.5	Symbols in graphics	6	9.3.1	Identification	21
1.3	Documentation	6	9.3.2	Configuring system units	22
1.4	Registered trademarks	6	9.3.3	Setting the installation direction and measurement	22
2	Basic safety instructions	7	9.3.4	Configuring the IO modules	23
2.1	Requirements for the personnel	7	9.3.5	Totalizer	28
2.2	Designated use	7	9.3.6	Configuring the display	29
2.3	Workplace safety	7	9.3.7	Security	30
2.4	Operational safety	8	9.3.8	Data management	30
2.5	Product safety	8	9.4	Pending diagnostic events	31
2.6	IT security	8	9.4.1	Simulation	31
2.7	Device-specific IT security	8	9.5	System	31
2.7.1	Access via the SmartBlue App	8	10	Operational	33
2.7.2	Protecting access via a password	8	10.1	Offline quick view of the configuration	33
2.7.3	Access via Bluetooth® wireless technology	9	11	Diagnostics and troubleshooting	35
3	Incoming acceptance and product identification	10	11.1	General troubleshooting	35
3.1	Incoming acceptance	10	11.2	Diagnostic information on local display	36
3.2	Product identification	10	11.2.1	Diagnostic message	36
3.2.1	Symbols on measuring device	11	11.3	Overview of diagnostic events	37
4	Storage and transport	12	11.4	Device information	38
4.1	Storage conditions	12	11.5	Firmware history	38
4.2	Transporting the product	12	12	Accessories	39
4.3	Packaging disposal	12	13	Technical data	41
5	Installation	13	13.1	Input	41
5.1	Installation conditions	13	13.2	Output	41
5.1.1	Mounting position	13	13.3	Power supply	41
5.2	Mounting the measuring device	13	13.4	Performance characteristics	41
6	Electrical connection	15	13.5	Installation	41
6.1	Connection conditions	15	13.6	Environment	42
6.1.1	Requirements for connecting cables	15	13.7	Process	42
6.1.2	Pin assignment, device plug	15	13.8	Mechanical construction	42
6.2	Connecting the measuring device	18	13.9	Operability	43
6.3	Post-connection check	18	13.10	Certificates and approvals	44
7	Operation options	19	14	Appendix	45
7.1	Access to the operating menu via the SmartBlue app	19	14.1	Radio approvals	45
			14.1.1	Europe	45
			14.1.2	Canada and USA	45
			14.1.3	India	45

14.1.4	Singapore	45
14.1.5	Thailand	46
14.1.6	Argentina	46
14.1.7	Taiwan	46
14.1.8	Brazil	46
14.1.9	South Korea	47
14.1.10	Other countries	47
14.2	IO-Link process data	48
14.2.1	Data structure	48
14.2.2	Diagnostic information	48
14.3	IO-Link ISDU parameter list	49
Index	57





1 About this document

1.1 Document function



These Operating Instructions contain all the information that is required in various phases of the life cycle of the device: from product identification, incoming acceptance and storage, to mounting, connection, operation and commissioning through to troubleshooting, maintenance and disposal.

1.2 Symbols used



1.2.1 Safety symbols

Symbol	Meaning
	DANGER! This symbol alerts you to a dangerous situation. Failure to avoid this situation will result in serious or fatal injury.
	WARNING! This symbol alerts you to a dangerous situation. Failure to avoid this situation can result in serious or fatal injury.
	CAUTION! This symbol alerts you to a dangerous situation. Failure to avoid this situation can result in minor or medium injury.
	NOTE! This symbol contains information on procedures and other facts which do not result in personal injury.



1.2.2 Electrical symbols









Symbol	Meaning
	Direct current
	Alternating current

1.2.3 Communication symbols



Symbol	Meaning
	Bluetooth® Wireless data transmission between devices over a short distance.
	IO-Link Communications system for connecting intelligent sensors and actuators to an automation system. The IO-Link technology is standardized under the description "Single-drop digital communication interface for small sensors and actuators (SDCI)" in the IEC 61131-9 standard.

1.2.4 Symbols for certain types of information

Symbol	Meaning
	Permitted Procedures, processes or actions that are permitted.
	Preferred Procedures, processes or actions that are preferred.

Symbol	Meaning
	Forbidden Procedures, processes or actions that are forbidden.
	Tip Indicates additional information.
	Reference to documentation
	Reference to page
	Reference to graphic
	Notice or individual step to be observed
	Series of steps
	Result of a step

1.2.5 Symbols in graphics

Symbol	Meaning
	Item numbers
	Views

1.3 Documentation

 For an overview of the scope of the associated Technical Documentation, refer to the following:

- The *W@M Device Viewer*: Enter the serial number of the measuring device ([deviceviewer](#))
- The *Operations App*: Enter the serial number of the measuring device or scan the 2-D matrix code on the measuring device.

1.4 Registered trademarks

IO-Link®

Is a registered trademark. It may only be used in conjunction with products and services by members of the IO-Link Community or by non-members who hold an appropriate license. For more detailed information on the use of IO-Link, please refer to the rules of the IO-Link Community at: www.io.link.com.

Bluetooth® wireless technology



The Bluetooth® word mark and logos are registered trademarks owned by the Bluetooth SIG, Inc. and any use of such marks is under license.

Apple®

Apple, the Apple logo, iPhone, and iPod touch are trademarks of Apple Inc., registered in the U.S. and other countries. App Store is a service mark of Apple Inc.

Android®

Android, Google Play and the Google Play logo are trademarks of Google Inc.

2 Basic safety instructions

2.1 Requirements for the personnel

The personnel for installation, commissioning, diagnostics and maintenance must fulfill the following requirements:

- ▶ Trained, qualified specialists must have a relevant qualification for this specific function and task.
- ▶ Are authorized by the plant owner/operator.
- ▶ Are familiar with federal/national regulations.
- ▶ Before starting work, read and understand the instructions in the manual and supplementary documentation as well as the certificates (depending on the application).
- ▶ Follow instructions and comply with basic conditions.

The operating personnel must fulfill the following requirements:

- ▶ Are instructed and authorized according to the requirements of the task by the facility's owner-operator.
- ▶ Follow the instructions in this manual.

2.2 Designated use

Application and media

The measuring device described in these Brief Operating Instructions is intended only for flow measurement of liquids with a minimum conductivity of 20 $\mu\text{S}/\text{cm}$.

To ensure that the measuring device remains in proper condition for the operation time:

- ▶ Use the measuring device only for media against which the process-wetted materials are adequately resistant.

Incorrect use

Non-designated use can compromise safety. The manufacturer is not liable for damage caused by improper or non-designated use.

WARNING

Danger of breakage due to corrosive or abrasive fluids and ambient conditions!

- ▶ Verify the compatibility of the process fluid with the sensor material.
- ▶ Ensure the resistance of all fluid-wetted materials in the process.
- ▶ Keep within the specified pressure and temperature range.

Residual risks

WARNING

The electronics and the medium may cause the surfaces to heat up. This presents a burn hazard!

- ▶ For elevated fluid temperatures, ensure protection against contact to prevent burns.

2.3 Workplace safety

For work on and with the device:

- ▶ Wear the required personal protective equipment according to federal/national regulations.

For welding work on the piping:

- ▶ Do not ground the welding unit via the measuring device.

2.4 Operational safety

Risk of injury!

- ▶ Operate the device in proper technical condition and fail-safe condition only.
- ▶ The operator is responsible for interference-free operation of the device.

2.5 Product safety

This measuring device is designed in accordance with good engineering practice to meet state-of-the-art safety requirements, has been tested, and left the factory in a condition in which it is safe to operate.

It meets general safety standards and legal requirements. It also complies with the EU directives listed in the device-specific EU Declaration of Conformity.

2.6 IT security

Our warranty is valid only if the device is installed and used as described in the Operating Instructions. The device is equipped with security mechanisms to protect it against any inadvertent changes to the settings.

IT security measures, which provide additional protection for the device and associated data transfer, must be implemented by the operators themselves in line with their security standards.

2.7 Device-specific IT security

2.7.1 Access via the SmartBlue App

Two access levels (user roles) are defined for the device: the **Operator** user role and the **Maintenance** user role. The **Maintenance** user role is the default setting.

If a user-specific access code is not defined (in the **Set access code** parameter), the default setting **0000** continues to apply and the **Maintenance** user role is automatically enabled. The device's configuration data are not write-protected and can be edited at all times.

If a user-specific access code has been defined (in the **Set access code** parameter), all the parameters are write-protected and the device is accessed with the **Operator** user role. The previously defined access code must first be entered again before the **Maintenance** user role is enabled and all the parameters can be write-accessed.

2.7.2 Protecting access via a password

Different passwords are available to protect write access to the device parameters or access to the device via the Bluetooth® interface.

- User-specific access code
Protect write access to the device parameters via the SmartBlue app
- Bluetooth key
The password protects a connection between an operating device (e.g. smartphone, tablet) and the device via the Bluetooth® interface.

General notes on the use of passwords

- The access code and Bluetooth key supplied with the device should be changed during commissioning.
- Follow the general rules for generating a secure password when defining and managing the access code or Bluetooth key.
- The user is responsible for the management and careful handling of the access code and Bluetooth key.

2.7.3 Access via Bluetooth® wireless technology

Secure signal transmission via Bluetooth® wireless technology uses an encryption method tested by the Fraunhofer Institute.

- The device is not visible via *Bluetooth*® wireless technology without the SmartBlue app.
- Only one point-to-point connection is established between the device and a smartphone or tablet.
- The *Bluetooth*® wireless technology interface can be disabled via SmartBlue.

3 Incoming acceptance and product identification

3.1 Incoming acceptance

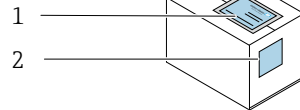

Are the order codes on the delivery note (1) and the product sticker (2) identical?

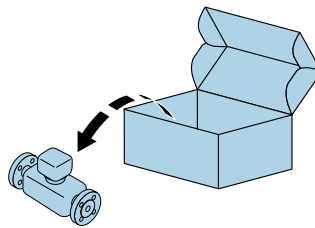

Are the goods undamaged?

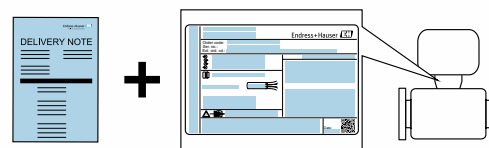

Do the nameplate data match the ordering information on the delivery note?

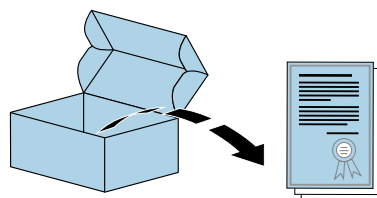

Is the accompanying safety data sheet present?





- If one of the conditions is not satisfied, contact your Sales Center.
- Depending on the device version, the CD-ROM might not be part of the delivery! The Technical Documentation is available via the Internet or via the *Operations App*, see the "Product identification" section .

3.2 Product identification

The following options are available for identification of the measuring device:

- The device label
- Order code with breakdown of the device features on the delivery note
- Enter the serial number on the device label in *W@M Device Viewer* ([deviceviewer](#)): all the information about the measuring device is displayed.
- Enter the serial number on the device label into the *Operations App* or scan the 2-D matrix code (QR code) on the measuring device with the *Operations App*: all the information about the measuring device is displayed.

3.2.1 Symbols on measuring device

Symbol	Meaning
	WARNING! This symbol alerts you to a dangerous situation. Failure to avoid this situation can result in serious or fatal injury.
	Reference to documentation Refers to the corresponding device documentation.

4 Storage and transport

4.1 Storage conditions

Observe the following notes for storage:

- ▶ Store in the original packaging to ensure protection from shock.
- ▶ Store in a dry place.
- ▶ Do not store outdoors.

Storage temperature →  42

4.2 Transporting the product

Transport the device to the measuring point in the original packaging.

 Do not remove protective covers or caps installed on process connections. They prevent mechanical damage to the sealing surfaces and contamination in the measuring tube.

4.3 Packaging disposal

All packaging materials are environmentally friendly and 100% recyclable:
Carton in accordance with European Packaging Directive 94/62EC; recyclability is confirmed by the affixed RESY symbol.

5 Installation

5.1 Installation conditions

5.1.1 Mounting position

Mounting location

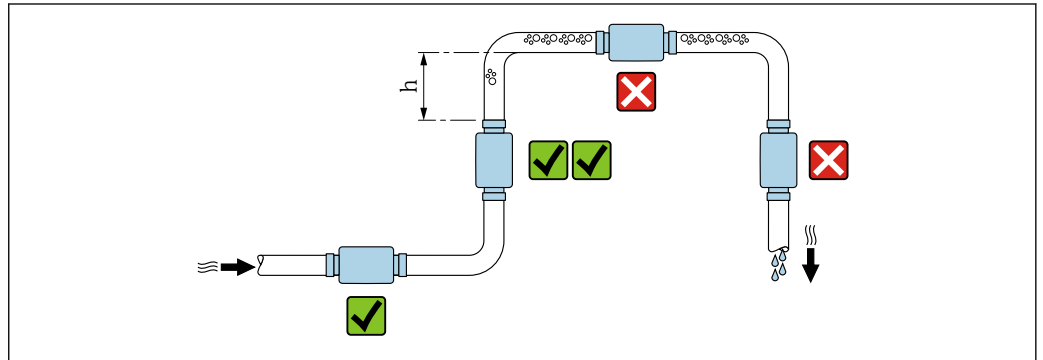

A0032998



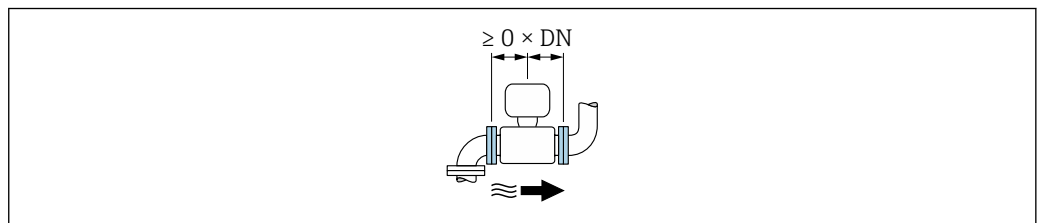

Preferably install the sensor in an ascending pipe, and ensure a sufficient distance to the next pipe elbow: $h \geq 2 \times DN$

Inlet and outlet runs

No inlet and outlet runs need to be considered.



A0032859

-  Installation dimensions: information on the dimensions and installed lengths of the device →  42
-  The arrow points in the preferred direction of flow. Measurement in the other direction is also possible. →  22

5.2 Mounting the measuring device

WARNING

Burn hazard!

If medium temperatures or ambient temperatures exceed 50 °C, areas of the housing can heat to over 65 °C.

- ▶ Safeguard the housing so that it cannot be touched accidentally.

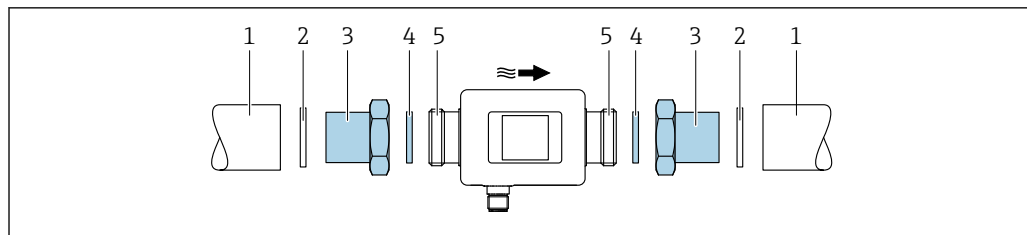

A0039002

- 1 Pipe
- 2 Seal (not supplied)
- 3 Adapter: available adapters →  39
- 4 Seal (included in delivery)
- 5 Measuring device connection

6 Electrical connection

6.1 Connection conditions

6.1.1 Requirements for connecting cables

National regulations and standards apply.

Connecting cable	M12 × 1 A-coded
Conductor cross-section	At least 0.12 mm ² (AWG26)
Temperature range	-10 to +90 °C (+14 to +194 °F)
Degree of protection	IP65/67, pollution degree 3
Humidity and moisture	Suitable for indoor environments with up to 100% rh (wet and damp locations)

6.1.2 Pin assignment, device plug

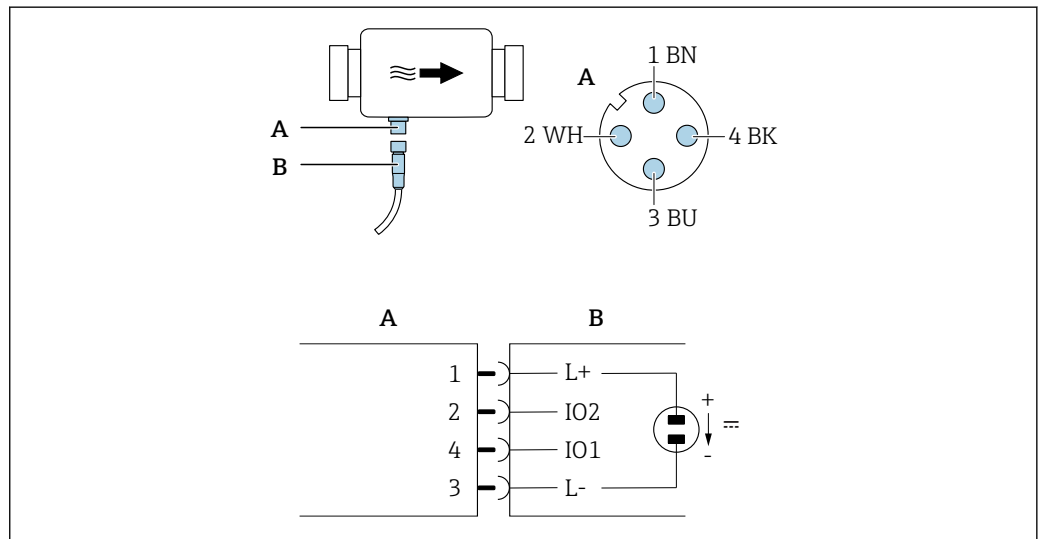

A Connector (Picomag)
 B Socket (Customer side)

Pin	Assignment	Color	Description
1	L+	Brown	Supply voltage + (18 to 30 V _{DC} /max. 3 W)
2	IO2	White	Input/output 2, can be configured independently of IO1
3	L-	Blue	Supply voltage -
4	IO1	Black	Input/output 1, can be configured independently of IO2

Switch output configuration version

The switching behaviour of IO1 and IO2 can be configured independently of one another.

pnp ¹⁾	npn ²⁾
<p>A Connector (Picomag) B Socket (Customer side) L+ Supply voltage + L- Supply voltage -</p>	<p>A Connector (Picomag) B Socket (Customer side) L+ Supply voltage + L- Supply voltage -</p>
<p>The load is switched to high side L+. The maximum load current is 250 mA. The output is overload-resistant.</p>	<p>The load is switched to low side L-. The maximum load current is 250 mA. The output is overload-resistant.</p>

- 1) positive negative positive (high side switch)
- 2) negative positive negative (low side switch)

Pulse output configuration version

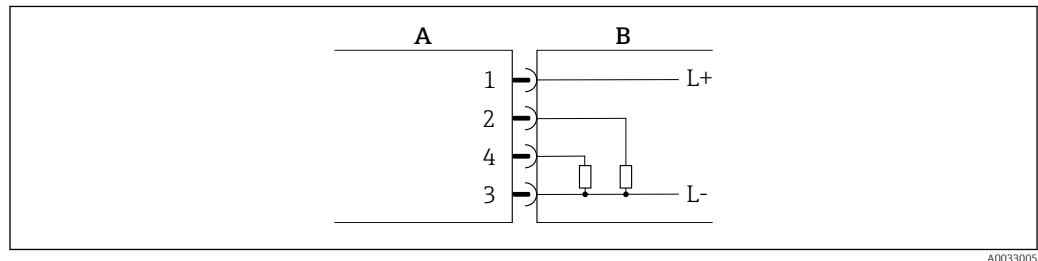

1 Pulse output with pnp switching behaviour

- A Connector (Picomag)
- B Socket (Customer side)
- L+ Supply voltage +
- L- Supply voltage -

The load is switched to high side L+. The maximum load current is 250 mA. The output is overload-resistant.

Current output configuration version

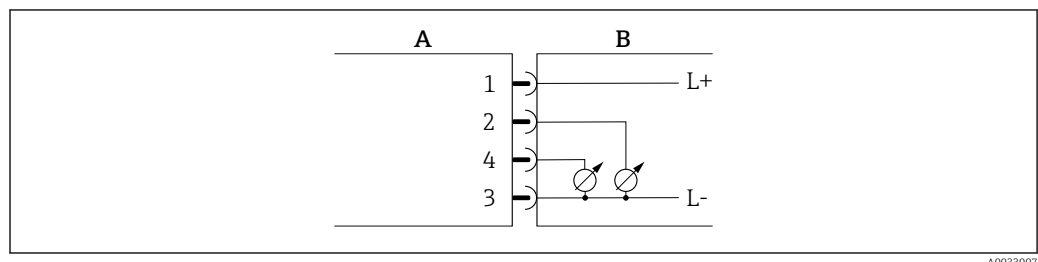

2 Current output, active, 4 to 20 mA

- A Connector (Picomag)
- B Socket (Customer side)
- L+ Supply voltage +
- L- Supply voltage -

The current flows from the output to L-. The maximum load may not exceed 500 Ω. A bigger load distorts the output signal.

Voltage output configuration version

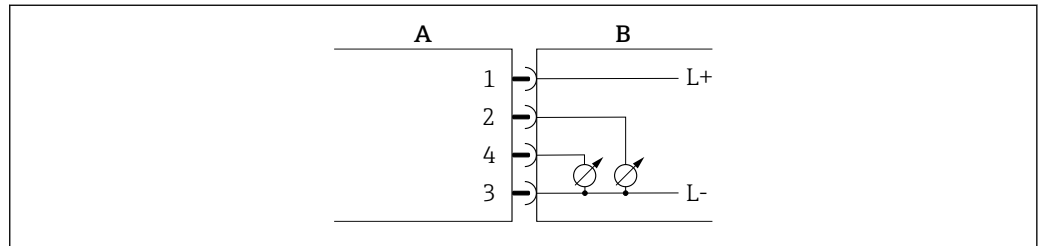

A0033007

3 Voltage output, active, 2 to 10 V

A Connector (Picomag)
 B Socket (Customer side)
 L+ Supply voltage +
 L- Supply voltage -

The voltage from the output applies to L-. The load must be at least 500 Ω. The output is overload-resistant.

Status input configuration version

- 15 V (switch-on threshold)
- 5 V (switch-off threshold)

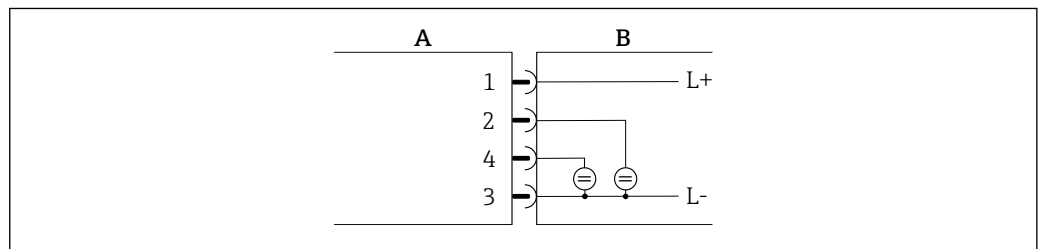



A0033008

4 Status input

A Connector (Picomag)
 B Socket (Customer side)
 L+ Supply voltage +
 L- Supply voltage -

Internal resistance: 7.5 kΩ

IO-Link configuration version

 Option only available for output 1 in the **Output 1** →  2.3 submenu

The measuring device features an IO-Link communication interface with a baud rate of 38,400 and with a second IO function on pin 2. This requires an IO-Link compatible module (IO-Link master) for operation. The IO-Link communication interface allows direct access to the process and diagnostics data.

6.2 Connecting the measuring device

NOTICE

The measuring device may only be installed by properly trained technicians.

- ▶ Comply with national and international regulations regarding the installation of electrotechnical systems.
- ▶ Power supply according to EN 50178, SELV, PELV or Class 2.

1. De-energize the system.
2. Connect the measuring device via the connector.
- 3.

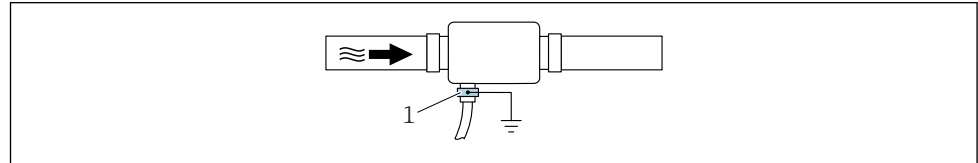

A0033003

In the case of non-grounded pipes:

The device must be grounded using the ground terminal accessory.

6.3 Post-connection check

Are cables or the device undamaged (visual inspection)?	<input type="checkbox"/>
Do the cables have adequate strain relief?	<input type="checkbox"/>
Is the connector connected correctly?	<input type="checkbox"/>
Does the supply voltage match the specifications on the measuring device?	<input type="checkbox"/>
Is the pin assignment of the connector correct?	<input type="checkbox"/>
Is the potential equalization established correctly?	<input type="checkbox"/>

7 Operation options

7.1 Access to the operating menu via the SmartBlue app

The device can be operated and configured via the SmartBlue app. In this case, the connection is established via the Bluetooth® wireless technology interface.

Supported functions

- Device selection in Live List and access to the device (login)
- Configuration of the device
- Access to measured values, device status and diagnostics information

The SmartBlue app is available for free download for Android devices (Google Playstore) and iOS devices (iTunes Apple Shop) : *SmartBlue*

Directly to the app with the QR code:

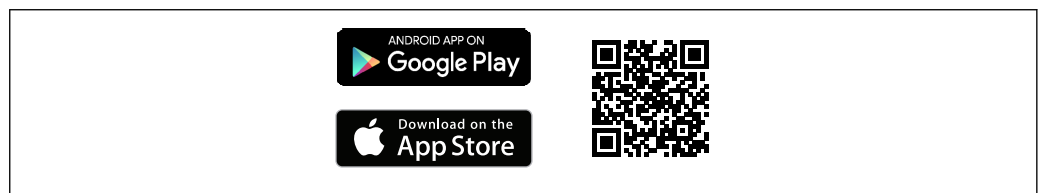

A0033202

System requirements

- Devices with iOS:
iOS9.0 or higher
- Devices with Android:
Android 4.4 KitKat or higher

Download the SmartBlue app:

1. Install and start the SmartBlue app.
 - ↳ A Live List shows all the devices available.
The list displays the devices with the configured tag name. The default setting for the tag name is **EH_DMA_XYZZ** (XYZZ = the last 7 digits of the device serial number).
2. For Android devices, activate GPS positioning (not necessary for devices with IOS)
3. Select the device from the Live List.
 - ↳ The Login dialog box opens.

Logging in:

4. Enter the user name: **admin**.
 5. Enter the initial password: serial number of the device.
 - ↳ When you log in for the first time, a message is displayed advising you to change the password.
 6. Confirm your entry.
 - ↳ The main menu opens.
 7. Optional: Change the password:
-  Navigate through the various items of information about the device: swipe the screen to the side.



8 System integration

The measuring device has an IO-Link communication interface. The IO-Link interface allows direct access to process and diagnostics data and enables the user to configure the measuring device on the fly.

Properties:

- IO-Link Specification: Version 1.1
- IO-Link Smart Sensor Profile 2nd Edition
- SIO mode: yes
- Speed: COM2 (38.4 kBaud)
- Minimum cycle time: 10 ms
- Process data width: 120 bit
- IO-Link data storage: yes
- Block configuration: no
- Device operational: The measuring device is operational 4 seconds after the supply voltage is applied

 More information on IO-Link is available at www.io-link.com

 Overview of the entire IO-Link ISDU parameter list →  49

8.1 Overview of device description files

Current version data for the device

Firmware version	01.01.zz	<ul style="list-style-type: none"> ▪ On the title page of the Operating Instructions ▪ On the device label ▪ Firmware version system parameter
Release date of firmware version	05.2019	---
Profile version	<ul style="list-style-type: none"> ▪ 1.1 ▪ Smart Sensor Profile 	---

8.2 Device master file

In order to integrate field devices into a digital communication system, the IO-Link system needs a description of the device parameters, such as output data, input data, data format, data volume and supported transmission rate.

These data are available in the device master file (IODD ¹⁾) which is provided to the IO-Link Master via generic modules when the communication system is commissioned.

 The IODD can be downloaded as follows:

- IODDfinder: ioddfinder.io-link.com

1) IO Device Description

9 Commissioning

9.1 Switching ON the measuring device

Once the supply voltage has been switched on, the measuring device adopts the normal mode after a maximum of 4 s. During the start-up phase, the outputs are in the same state as the measuring device in the switched-off state.

9.2 Overview of the operating menu

Overview of the operating menu

Guidance	
	<ul style="list-style-type: none"> ▶ Identification → 21 ▶ System units → 22 ▶ Sensor → 22 ▶ Output 1 → 23 ▶ Output 2 → 23 ▶ Totalizer → 28 ▶ Display → 29 ▶ Security → 30 ▶ Data management → 30
Diagnostics	
	<ul style="list-style-type: none"> ▶ Actual diagnostics → 31 ▶ Simulation → 31
System	
	<ul style="list-style-type: none"> ▶ Data management → 31 ▶ Firmware → 31

9.3 Configuring the measuring device

9.3.1 Identification

The device tag and the user level can be changed in the **Identification** submenu.

Navigation

Menu: "Guidance" → Identification

9.3.2 Configuring system units

In the **System units** submenu, you can configure the units of all measured values.

Navigation

Menu: "Guidance" → System units

Parameter overview with brief description

Parameter	Description	Selection	Factory setting
Volume flow unit	Select volume flow unit.	<ul style="list-style-type: none"> ▪ l/s, m³/h, l/min, l/h ▪ gal/min (us), fl. oz/min 	l/min
Volume unit	Select volume unit.	<ul style="list-style-type: none"> ▪ ml, l, m³ ▪ fl. oz (us), gal (us) 	ml
Temperature unit	Select temperature unit.	<ul style="list-style-type: none"> ▪ °C ▪ °F 	°C
Totalizer unit	Select totalizer unit.	<ul style="list-style-type: none"> ▪ l, m³ ▪ 1000 l, 1000 m³ ▪ fl. oz (us), gal (us) ▪ 1000 gal (us) 	m ³
Conductivity unit	Select the unit for conductivity.	<ul style="list-style-type: none"> ▪ µS/cm ▪ S/m ▪ ms/cm 	µS/cm

9.3.3 Setting the installation direction and measurement

The **Sensor** submenu contains parameters for specific settings of the measuring device.

Navigation





Menu: "Guidance" → Sensor

Parameter overview with brief description

Parameter	Description	Selection/input	Factory setting
Installation direction	Select the installation direction.	<ul style="list-style-type: none"> ▪ Flow in arrow direction (forwards) Positive flow measurement in the direction of the arrow. ▪ Flow against arrow direction (backwards) Positive flow measurement in the opposite direction of the arrow. 	Flow in arrow direction (forwards)
On value	Enter the on value for low flow cut off.	Positive floating point number  A flow measured value that is less than the value of the on value forces the display to zero. In the event of plant downtime, this prevents the totalizer from continuing to totalize even though there is no flow.	Depends on the nominal diameter: DN 15 (1/2"): 0.05 l/min (0.013 gal/min) DN 20 (3/4"): 0.1 l/min (0.026 gal/min) DN 25 (1"): 0.2 l/min (0.052 gal/min) DN 50 (2"): 1.5 l/min (0.4 gal/min)
Damping	Enter the time constant for damping the flow measured value.	0 to 10 s	0 s

9.3.4 Configuring the IO modules

The measuring device has two signal inputs or signal outputs that can be configured independently of one another:

- Current output →  23
- Pulse output →  24
- Switch output →  25
- Voltage output →  26
- Status input →  28

Navigation

Menu: "Guidance" → Output 1

Menu: "Guidance" → Output 2

Parameter overview with brief description

Parameter	Description	Selection	Factory setting
Output 1	Select the operating mode of output 1.	<ul style="list-style-type: none"> ■ Pulse output ■ Current output ■ Switch output ■ Voltage output ■ Digital input ■ IO-Link ■ Off 	IO-Link
Output 2	Select the operating mode of output 2.	<ul style="list-style-type: none"> ■ Current output ■ Switch output ■ Voltage output ■ Digital input ■ Off 	Off

Configuring the current output

The Current output submenu contains all the parameters that must be configured for the configuration of the current output.

The output is used to output process variables by analog means in the form of a 4-20 mA current.

Navigation

Menu: "Guidance" → Output 1 → Current output

Menu: "Guidance" → Output 2 → Current output

Parameter overview with brief description

Parameter	Description	Selection/input	Factory setting
Assign current output	Select process variable for current output.	<ul style="list-style-type: none"> ■ Off ■ Volume flow ■ Temperature ■ Conductivity 	Volume flow
4 mA value	Enter 4 mA value.	Floating point number with sign	0 l/min
20 mA value	Enter 20 mA value.	Floating point number with sign	Depends on the nominal diameter: DN 15 (½"): 25 l/min (6.6 gal/min) DN 20 (¾"): 50 l/min (13.2 gal/min) DN 25 (1"): 100 l/min (26.4 gal/min) DN 50 (2"): 750 l/min (198.1 gal/min)

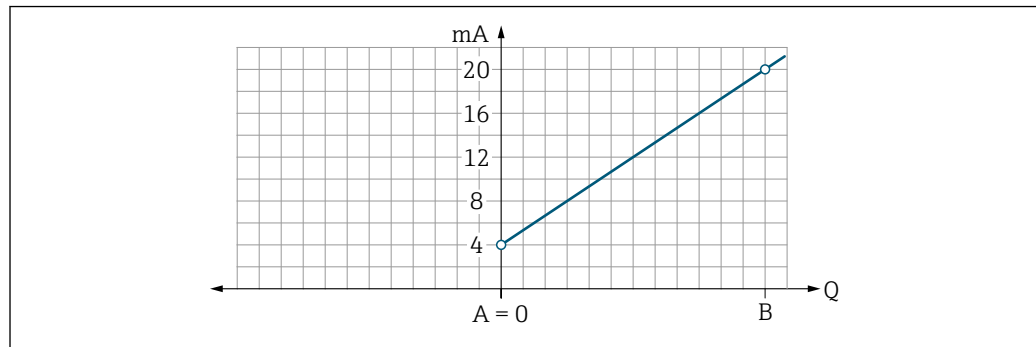
Unidirectional flow measurement (Q), conductivity measurement

A Lower range value = 0
 B Upper range value
 Q Flow

- Current I is linearly interpolated between lower range value (A) and upper range value (B).
- The output range ends at 20.5 mA.

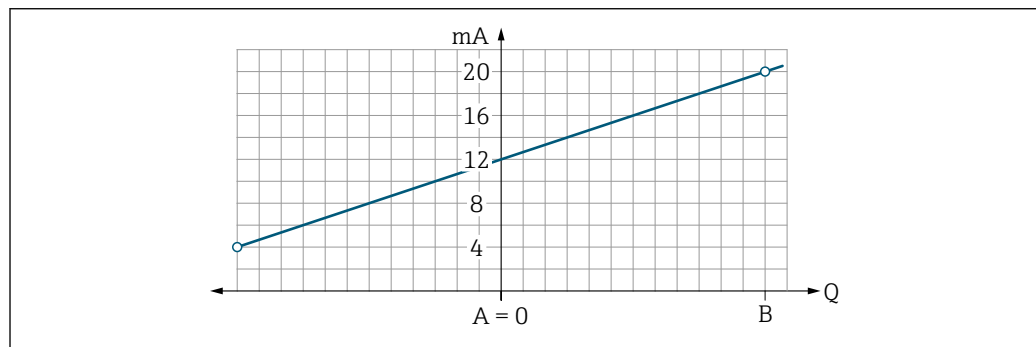
Bidirectional flow measurement (Q), temperature measurement (T)

A Lower range value
 B Upper range value
 Q Flow

- Current I is linearly interpolated between lower range value (A) and upper range value (B).
- Rather than having a hard upper and lower limit, the output range ends at 20.5 mA at the top end and at 3.8 mA at the bottom end.

Configuring the pulse output

The Pulse output submenu contains all the parameters that must be configured for the configuration of the pulse output.

Navigation

Menu: "Guidance" → Output 1

Menu: "Guidance" → Output 2

Parameter overview with brief description

Parameter	Description	User entry	Factory setting
Value per pulse	Enter the value for the pulse output.	Floating point number with sign	Depends on the nominal diameter: DN 15 (½"): 0.5 ml DN 20 (¾"): 1.0 ml DN 25 (1"): 2.0 ml DN 50 (2"): 10.0 ml

The current pulse repetition frequency is calculated from the current flow and the configured pulse value:

$$\text{Pulse repetition frequency} = \text{flow/pulse value}$$

Example

- Flow: 300 ml/min
- Pulse value: 0.001 l
- Pulse repetition frequency = 5 000 Pulse/s

The pulse output only outputs positive flow components in the set installation direction. Negative flow components are ignored and not balanced.

Configuring the switch output

The Switch output submenu contains all the parameters that must be configured for the configuration of the switch output.

Navigation

Menu: "Guidance" → Output 1

Menu: "Guidance" → Output 2

Parameter overview with brief description

Parameter	Description	Selection/input	Factory setting
Polarity	Select the switching behavior.	<ul style="list-style-type: none"> ■ NPN (low-side-switch) Switches load to low side to L- ■ PNP (high-side-switch) Switches load to high side to L+ 	PNP (high-side-switch)
Switch output function		<ul style="list-style-type: none"> ■ Off The switch output is permanently switched off (open, non-conductive). ■ On The switch output is permanently switched on (closed, conductive). ■ Diagnostic behavior The output switches when an event with the status signal F occurs ■ Limit volume flow Indicates if a specified limit value is reached for the process variable. ■ Limit temperature Indicates if a specified limit value is reached for the process variable. ■ Limit conductivity. Indicates if a specified limit value is reached for the process variable. ■ Limit volume totalizer Range volume totalizer ■ Range volume flow ■ Range temperature ■ Range conductivity ■ Range volume totalizer ■ Empty pipe detection Output switches off if empty pipe detection is activated. 	Off

Parameter	Description	Selection/input	Factory setting
Switch-on value	Enter the measured value for the switch-on value.	Floating point number with sign	1000 m ³ /h
Switch-off value	Enter the measured value for the switch-off value.	Floating point number with sign	1000 m ³ /h

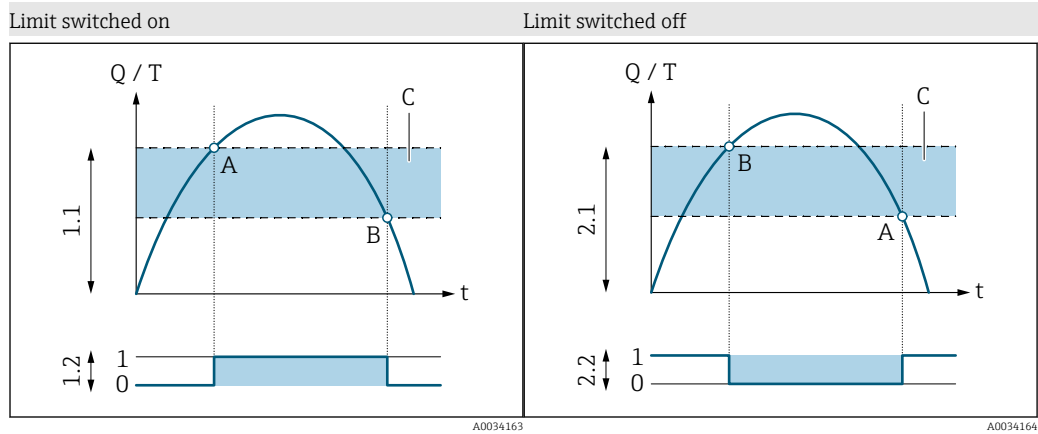

- 1.1 Input variables
- 1.2 Switch output
- A Switch-on value
- B Switch-off value
- C Hysteresis

- 2.1 Input variables
- 2.2 Switch output
- A Switch-on value
- B Switch-off value
- C Hysteresis

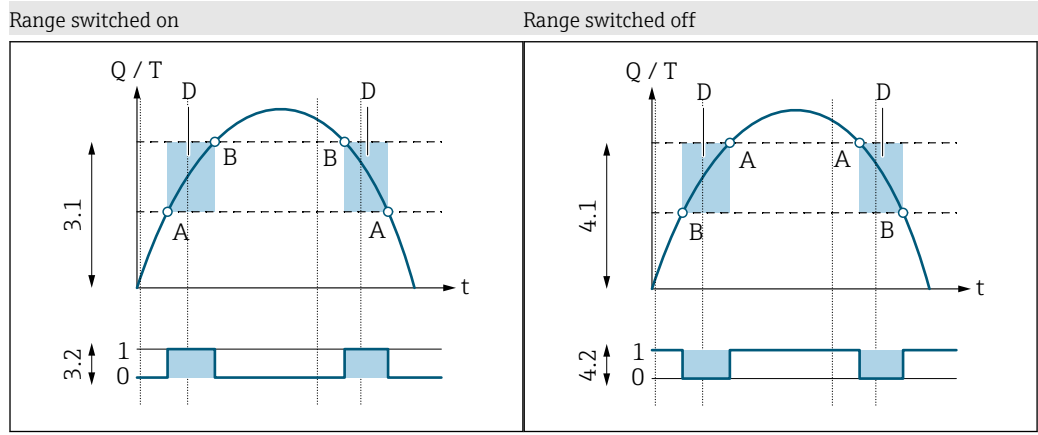

- 3.1 Input variables
- 3.2 Switch output
- A On-value (lower range limit)
- B Off-value (upper range limit)
- D Window

- 4.1 Input variables
- 4.2 Switch output
- A On-value (lower range limit)
- B Off-value (upper range limit)
- D Window

Configuring the voltage output

The Voltage output submenu contains all the parameters that must be configured for the configuration of the voltage output.

Navigation

Menu: "Guidance" → Output 1

Menu: "Guidance" → Output 2

Parameter overview with brief description

Parameter	Description	Selection/input	Factory setting
Assign voltage output	Select process variable for voltage output.	<ul style="list-style-type: none"> ■ Off ■ Volume flow ■ Temperature ■ Conductivity 	Volume flow
2 V value	Enter the lower range value.	Floating point number with sign	0 l/min
10 V value	Enter the upper range value.	Floating point number with sign	Depends on the nominal diameter: DN 15 (½"): 25 l/min DN 20 (¾"): 50 l/min DN 25 (1"): 100 l/min DN 50 (2"): 750 l/min

Unidirectional flow measurement (Q), conductivity measurement

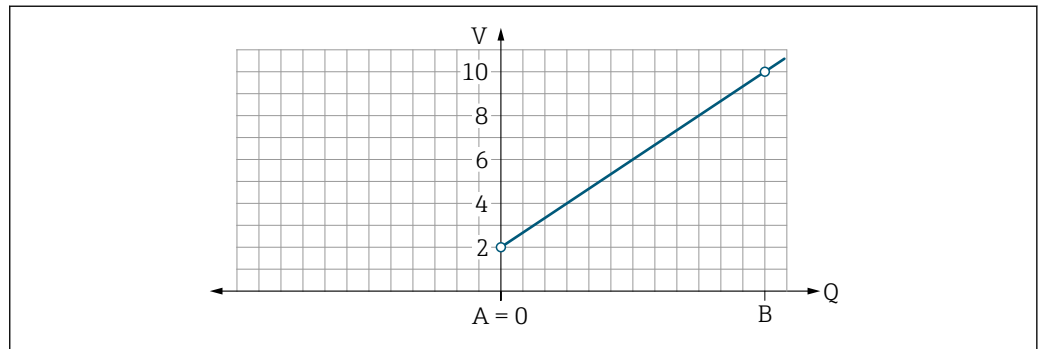

A0032995

- A Lower range value = 0
- B Upper range value
- Q Flow

- Voltage U is linearly interpolated between lower range value (A) and upper range value (B).
- The output range ends at 10.25 V.

Bidirectional flow measurement (Q), temperature measurement (T)

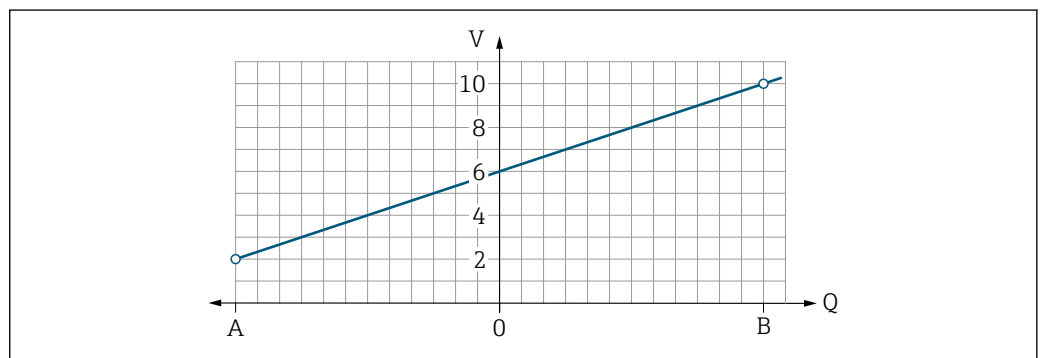

A0032996

- A Lower range value
- B Upper range value
- Q Flow

- Voltage U is linearly interpolated between lower range value (A) and upper range value (B).
- Rather than having a hard upper and lower limit, the output range ends at 10.25 V at the top end and at 1.9 V at the bottom end.

Configuring the status input

The **Digital input** submenu contains all the parameters that must be configured for the configuration of the digital input.

The input is used to control an action with an external voltage signal. The minimum pulse duration is 100 ms.

Navigation

Menu: "Guidance" → Output 1

Menu: "Guidance" → Output 2

Parameter overview with brief description

Parameter	Description	Selection	Factory setting
Active level	Select the switching behavior of the digital input.	<ul style="list-style-type: none"> ▪ High Input reacts to high level ▪ Low Input reacts to low level 	High
Assign status input	Select the function for the status input.	<ul style="list-style-type: none"> ▪ Off ▪ Reset totalizer Resets the totalizer ▪ Flow override <ul style="list-style-type: none"> – Flow measured value = 0 – Does not affect the temperature measurement 	Reset totalizer

9.3.5 Totalizer

The totalizer can be reset with the **Reset totalizer** submenu.

Navigation

Menu: "Guidance" → Totalizer

Parameter overview with brief description

Parameter	Description	Display/options	Factory setting
Volume totalizer	Enter value.	Floating point number with sign	0 m ³
Reset totalizer	Reset the totalizer.	<ul style="list-style-type: none"> ▪ Cancel The totalizer is not reset. ▪ Reset + totalize The totalizer is reset. 	Cancel

9.3.6 Configuring the display

The **Display** submenu contains all the parameters that can be configured for the configuration of the onsite display.

Navigation

Menu: "Guidance" → Display

Parameter overview with brief description

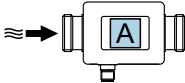
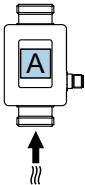
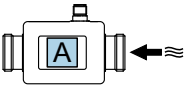
Parameter	Description	Selection/input	Factory setting
Format display	Select how measured values are shown on the display.	Display value 1st line + display value 2nd line: <ul style="list-style-type: none"> ▪ Volume flow + temperature ▪ Volume flow + totalizer ▪ Temperature + totalizer ▪ Volume flow + conductivity ▪ Totalizer + conductivity ▪ Temperature + conductivity 4 display values: Volume flow + temperature + totalizer + conductivity 2 display values (multiplex): Volume flow +totalizer / temperature + conductivity	Volume flow + temperature
Rotation display	Select local display rotation.	<ul style="list-style-type: none"> ▪ Auto (automatic) ▪ The display rotates automatically depending on the installation position <div style="border: 1px solid black; padding: 5px; margin: 5px 0;"> <ul style="list-style-type: none"> ▪ 0° ▪ Can be read in the horizontal installation position with flow from left to right  <p style="text-align: right; font-size: small;">A0033013</p> </div> <div style="border: 1px solid black; padding: 5px; margin: 5px 0;"> <ul style="list-style-type: none"> ▪ 90° ▪ Can be read in the vertical installation position with flow from bottom to top  <p style="text-align: right; font-size: small;">A0033014</p> </div> <div style="border: 1px solid black; padding: 5px; margin: 5px 0;"> <ul style="list-style-type: none"> ▪ 180° ▪ Can be read in the horizontal installation position with flow from right to left  <p style="text-align: right; font-size: small;">A0033015</p> </div>	Auto

Parameter	Description	Selection/input	Factory setting
		<ul style="list-style-type: none"> ▪ 270° ▪ Can be read in the vertical installation position with flow from top to bottom  <p style="text-align: right; font-size: small;">A0033016</p>	
Backlight	Set the intensity of the backlighting.	0 to 100 %	50 %

9.3.7 Security

The **Security** submenu contains all the parameters required to define a new access code and to configure the Bluetooth connection.

Navigation

Menu: "Guidance" → Security

Parameter overview with brief description

Parameter	Description	Entry/selection/display	Factory setting
Define access code	Enter a user-specific access code to restrict write access to parameters.	Max. 4-digit string of numbers	0000
Bluetooth	Enable or disable the <i>Bluetooth</i> ® wireless technology interface.  If the interface is disabled, it can only be re-enabled by tapping the device.	<ul style="list-style-type: none"> ▪ Disable <ul style="list-style-type: none"> - Disable the interface. - The connection to the measuring device is torn down. ▪ Enable 	Enable
Change Bluetooth password	Change Bluetooth password	Character string comprising numbers, letters and special characters	-

Enable Bluetooth by tapping the device

1. Activate Bluetooth by tapping on the housing three times.
2. Establish a connection to the device via the SmartBlue app.

9.3.8 Data management

Export configuration as report

The device configuration can be exported as a PDF report and saved in the mobile terminal or forwarded with this function.

Save configuration to file

The device configuration is saved in the app. The saved device configuration can be transferred to another Picomag using the System → "Load configuration from app" function.

Navigation

Menu: "Guidance" → Data management

9.4 Pending diagnostic events

Navigation

Menu: "Diagnostics"

Parameter overview with brief description

Parameter	Prerequisite	Description	Display
Actual diagnostic	A diagnostic event has occurred.	Displays the current diagnostic event along with the diagnostic information.  If two or more messages occur simultaneously, the message with the highest priority is shown on the display.	Symbol for diagnostic behavior, diagnostic code and short message.
Simulation process variable	Enable variables for the simulation of the process variables.	<ul style="list-style-type: none"> ▪ Off Variables are disabled. ▪ On Variables are enabled. 	-
Volume flow value	Enter the value for volume flow simulation.	Positive floating point number	-
Temperature value	Enter the value for temperature simulation.	Positive floating point number	-
Conductivity value	Enter the value for conductivity simulation	Positive floating point number	-

9.4.1 Simulation

The **Simulation** submenu enables you to simulate, without a real flow situation, various process variables in the process and the device alarm mode and to verify downstream signal chains (switching valves or closed-control loops).

Navigation

Menu: "Diagnostics"

Parameter overview with brief description

Parameter	Description	Selection/input	Factory setting
Simulation process variable	Activate the simulation of process variables.	<ul style="list-style-type: none"> ▪ Off Simulation is deactivated. ▪ On Simulation is activated.  Deactivate the simulation again once the test has been performed.	Off
Volume flow value	Enter the value for volume flow simulation.	Positive floating point number	-
Temperature value	Enter the value for temperature simulation.	Positive floating point number	-
Conductivity value	Enter the value for conductivity simulation	Positive floating point number	-

9.5 System

The **System** submenu contains all the parameters that can be used for the administration of the device.

Navigation

Menu: "System"

Parameter overview with brief description

Parameter	Description	Entry/selection/display	Factory setting
Access status tooling	Displays the access status.	<ul style="list-style-type: none"> ■ Operator ■ Maintenance 	Maintenance
Enter access code	Enter the access code. Restrict write access to parameters in order to protect the device configuration from unauthorized modification.	Max. 4-digit string of numbers	0000
Device reset	Reset the entire device configuration or some of the configuration to a defined state.	<ul style="list-style-type: none"> ■ Cancel ■ To factory defaults ■ Restart device 	Cancel
Export configuration as report	The device configuration can be exported as a PDF report and saved in the mobile device or forwarded with this function.	-	-
Save configuration to file	The device configuration is saved in the app. The saved device configuration can be transferred to another Picomag using the System → "Load configuration from file" function.	-	-
Load Configuration from file	The saved device configuration can be uploaded to a new device with this function.	-	-
Reset Device	-	-	-
Firmware version	-	-	-
Firmware update	-	-	-

10 Operational

10.1 Offline quick view of the configuration

Tap the top of the housing (e.g. the arrow indicating the flow direction) with your knuckles or an object to display an overview of preconfigured parameters.

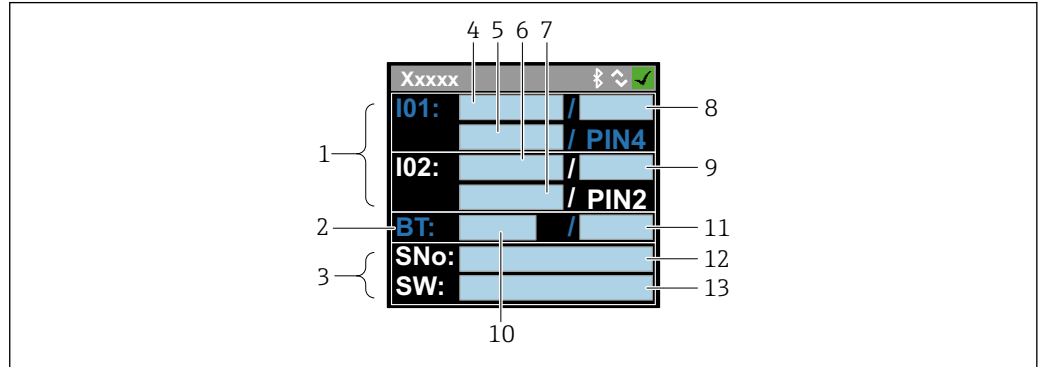



5 Information in the status layout, overview of the preconfigured parameters

- 1 I/O area
- 2 Bluetooth area
- 3 Identification area
- 4 I/O type 1
- 5 I/O current value type 1
- 6 I/O type 2
- 7 I/O current value type 2
- 8 I/O assignment type 1
- 9 I/O assignment type 2
- 10 Bluetooth module status
- 11 Bluetooth connection status
- 12 Serial number
- 13 Software version

I/O area (in brackets: item number → 5, 33)

I/O type (4, 6)	I/O assignment (8, 9)	I/O current value (5, 7)
S-Out	<ul style="list-style-type: none"> ▪ Alrt ▪ LimQ ▪ LimT ▪ LimV ▪ Lims ▪ WinQ 	<ul style="list-style-type: none"> ▪ WinT ▪ WinV ▪ Wins ▪ EPD ▪ Off ▪ On
I-Out	<ul style="list-style-type: none"> ▪ s ▪ Q ▪ T 	Off
U-Out	<ul style="list-style-type: none"> ▪ s ▪ Q ▪ T 	Off
S-In	<ul style="list-style-type: none"> ▪ RsT ▪ OvrD 	Off
P-Out	Q	PNPOn PNPOff
IO-L	PD	<ul style="list-style-type: none"> ▪ Dis. ▪ Start
Off	-	<ul style="list-style-type: none"> ▪ PNPOn ▪ NPNOff

Bluetooth area (in brackets: item number →  5,  33)

Bluetooth module status (12)	Bluetooth connection status (13)
On	Dis./Con.
Off	Dis.

11 Diagnostics and troubleshooting

11.1 General troubleshooting

For local display

Error	Possible causes	Solution
Local display dark and no output signals	Supply voltage does not match the value indicated on the nameplate.	Apply the correct supply voltage → 41.
	The polarity of the supply voltage is wrong.	Correct the polarity.
	The connecting cables are not connected correctly.	Check the cable connection and correct if necessary.

For output signals

Error	Possible causes	Solution
Device shows correct value on local display, but signal output is incorrect, though in the valid range.	Configuration error	Check and correct the parameter configuration.
Device measures incorrectly.	Configuration error or device is operated outside the application.	1. Check and correct parameter configuration. 2. Observe limit values specified in the "Technical Data".



For access

Error	Possible causes	Solution
Measuring device not in smartphone or tablet live list	Bluetooth communication is disabled	1. Check whether the Bluetooth logo is visible on the local display or not. 2. Re-enable Bluetooth communication by tapping the device three times.
No communication with device via SmartBlue app	No Bluetooth connection	Enable Bluetooth function on smartphone or tablet.
		The device is already connected with another smartphone/tablet.
Login via SmartBlue app not possible	Device is being put into operation for the first time	Enter initial password (device serial number) and change.
Device cannot be operated via SmartBlue app	Incorrect password entered	Enter correct password.
	Password forgotten	Contact Service.
No write access to parameters	Current user role has limited access authorization	1. Check user role 2. Enter correct customer-specific access code → 19.

11.2 Diagnostic information on local display

11.2.1 Diagnostic message

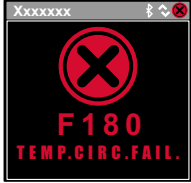
Faults detected by the self-monitoring system of the measuring device are displayed as a diagnostic message in alternation with the operational display.

Diagnostic message		
Alarm	Function check	Warning
 <p>A0033011</p>	 <p>A0033010</p>	 <p>A0033009</p>

If two or more diagnostic events are pending simultaneously, only the message of the diagnostic event with the highest priority is shown.



Status signals

The status signals provide information on the state and reliability of the device by categorizing the cause of the diagnostic information (diagnostic event).

 The status signals are categorized according to VDI/VDE 2650 and NAMUR Recommendation NE 107: F = Failure, C = Function Check, S = Out of Specification

Symbol	Meaning
F	Failure An operating error has occurred. The measured value is no longer valid.
C	Function check The device is in simulation mode.
S	Out of specification The device is being operated: <ul style="list-style-type: none"> ▪ Outside its technical specification limits (e.g. outside the process temperature range) ▪ Outside of the configuration carried out by the user (e.g. maximum flow in parameter 20 mA value)

Diagnostic behavior

Diagnostic message	Meaning
	Alarm <ul style="list-style-type: none"> ▪ Measurement is interrupted. ▪ Signal outputs and totalizers assume the defined alarm condition. ▪ A diagnostic message is generated.
	Function check Process measured values are simulated to test the outputs/wiring. <ul style="list-style-type: none"> ▪ IO1/IO2 overload ▪ Flow override is active
	Warning <ul style="list-style-type: none"> ▪ Measurement is resumed. ▪ Measuring operation with limited accuracy ▪ The signal outputs and totalizers are not affected. ▪ A diagnostic message is generated.

Diagnostics behavior of outputs

Output	Diagnostic behavior
Switch output	<ul style="list-style-type: none"> ▪ Setting for reporting events with the status signal F ▪ Switch output is switched on if an event occurs ▪ No further response to events with other status signals
Pulse output	<ul style="list-style-type: none"> ▪ Pulse output stops if events with the status signal F occur ▪ No further response to events with other status signals
Totalizer	<ul style="list-style-type: none"> ▪ Totalizing stops if events with the status signal F occur ▪ No further response to events with other status signals
Current output	<ul style="list-style-type: none"> ▪ 3.5 mA output to report events with the status signal F ▪ No further response to events with other status signals
Voltage output	<ul style="list-style-type: none"> ▪ 1.75 V output to report events with the status signal F ▪ No further response to events with other status signals
IO-Link	<ul style="list-style-type: none"> ▪ All events reported to the Master ▪ Events read and processed further by the Master

11.3 Overview of diagnostic events

Diagnostic event	Event text	Reason	Remedial measures	Status signal [ex-factory]
181	Coil. circ. fail.	Coil/frequency failure Coil current PWM outside tolerance range	Replace the measuring device.	F
180	Temp. circ. fail.	Temperature sensor open circuit/short-circuit	Replace the measuring device.	F
201	Device fail.	No communication to ADC/Nordic/BMA	Replace the measuring device.	F
283	Memory fail.	CRC failure	Reset to factory settings.	F
446	I/O 1 overload	Overload at output 1	Increase load impedance.	C
447	I/O 2 overload	Overload at output 2	Increase load impedance.	C
485	Simulation act.	Measured value simulation active (via remote configuration)	–	C
453	Flow override	Flow override active (via auxiliary input)	–	C
441	I-Out 1 range	I-output 1 at range limit	Adjust parameter or process.	S
444	U-Out 1 range	U-output 1 at range limit	Adjust parameter or process.	S
443	P-Out 1 range	P-output 1 at range limit	Adjust parameter or process.	S
442	I-Out 2 range	I-output 2 at range limit	Adjust parameter or process.	S
445	U-Out 2 range	U-output 2 at range limit	Adjust parameter or process.	S
962	Empty pipe	Pipe is completely or partially empty	Adjust the process.	S
834	Temperat. range	Medium temperature outside the permitted range	Adjust the process.	S
841	Flow range	Flow rate outside the permitted range	Adjust the process.	S

11.4 Device information

The **Device info** submenu contains all parameters that display different information for device identification.

Navigation

Menu: "System" → Device info

Parameter overview with brief description

Parameter	Description	User interface
Device name	Displays the name of the measuring device.	Picomag
Device tag	Shows name of measuring point.	Max. 32 characters, such as letters, numbers or special characters (e.g. @, %, /).
Serial number	Displays the serial number of the measuring device.	Max. 11-digit character string comprising letters and numbers.
Firmware version	Displays the device firmware version installed.	Character string in the format xx.yy.zz
Extended order code	Displays the extended order code.	Character string composed of letters, numbers and certain punctuation marks (e.g. /).

 The following information is shown on the display by tapping once on the housing:

- Status and values for output 1
- Status and values for output 2
- Bluetooth status (On/Off)
- Serial number
- Software version

11.5 Firmware history

Release date	Firmware version	Firmware changes	Documentation type	Documentation
09.2017	01.00.zz	Original firmware	Operating Instructions	BA01697D/06/EN/01.17 BA01697D/06/EN/02.17 BA01697D/06/EN/03.17
05.2019	01.01.zz	<ul style="list-style-type: none"> ▪ Conductivity measurement ▪ Export configuration report ▪ Save/load configuration ▪ Bug fix 	Operating Instructions	BA01697D/06/EN/04.19

12 Accessories

Various accessories are available for the device, and can be ordered with the device or at a later stage. An up-to-date overview of accessories is available from your local Sales Center or on the product page.

Adapter set

Order number	Description
71355698	G $\frac{1}{2}$ " to G $\frac{3}{8}$ " external thread
71355699	G $\frac{1}{2}$ " to R $\frac{3}{8}$ " external thread
71355700	G $\frac{1}{2}$ " to NPT $\frac{3}{8}$ " external thread
71355701	G $\frac{1}{2}$ " to G $\frac{1}{2}$ " internal thread
71355702	G $\frac{1}{2}$ " to R $\frac{1}{2}$ " external thread
71355703	G $\frac{1}{2}$ " to NPT $\frac{1}{2}$ " external thread
71355704	G $\frac{1}{2}$ " to $\frac{1}{2}$ " TriClamp
71355705	G $\frac{3}{4}$ " to R $\frac{3}{4}$ " external thread
71355706	G $\frac{3}{4}$ " to NPT $\frac{3}{4}$ " external thread
71355707	G $\frac{3}{4}$ " to G $\frac{3}{4}$ " internal thread
71355708	G $\frac{3}{4}$ " to R $\frac{3}{4}$ " TriClamp
71355709	G1" to R1" external thread
71355710	G1" to NPT1" external thread
71355711	G1" to G1" internal thread
71355712	G1" to 1" TriClamp
71355713	G2" to R1" external thread
71355714	G2" to R2" external thread
71355715	G2" to NPT1 $\frac{1}{2}$ " external thread
71355716	G2" to NPT2" external thread
71355717	G2" to G1 $\frac{1}{2}$ " external thread
71355718	G2" to G2" internal thread
71355719	G2" to 2" TriClamp
71355720	G2" to 2" Victaulic
71399930	G2" to 54mm press fitting

Cable set

Order number	Description
71349260	2m/6.5ft, straight, 4x0.34, M12, PUR
71349261	5m/16.4ft, straight, 4x0.34, M12, PUR
71349262	10m/32.8ft, straight, 4x0.34, M12, PUR
71349263	2m/6.5ft, 90 degrees, 4x0.34, M12, PUR
71349264	5m/16.4ft, 90 degrees, 4x0.34, M12, PUR
71349265	10m/32.8ft, 90 degrees, 4x0.34, M12, PUR

Seal set

Order number	Description
71354741	DMA15 Cent.3820
71354742	DMA20 Cent.3820
71354745	DMA25 Cent.3820
71354746	DMA50 Cent.3820

Ground terminal set

Order number	Description
71345225	Ground terminal

13 Technical data

13.1 Input

Measured variables	<ul style="list-style-type: none"> ▪ Volume flow ▪ Temperature ▪ Totalizer ▪ Conductivity
Measuring range	DN 15 (½"): 0.05 to 25 l/min (0.013 to 6.6 gal/min) DN 20 (¾"): 0.1 to 50 l/min (0.026 to 13.2 gal/min) DN 25 (1"): 0.2 to 100 l/min (0.052 to 26.4 gal/min) DN 50 (2"): 1.5 to 750 l/min (0.4 to 198.1 gal/min)
Digital input	<ul style="list-style-type: none"> ▪ High or low active ▪ Switch-on level 15 V ▪ Switch-off level 5 V ▪ Internal resistance 7.5 kOhm

13.2 Output

Output	Max. load
Current output	500 Ω Load must not be greater
Voltage output	500 Ω Load resistance must not be smaller
Signal on alarm	<ul style="list-style-type: none"> ▪ Status signal (as per NAMUR Recommendation NE 107) ▪ Plain text display with remedial action
Switch output	<ul style="list-style-type: none"> ▪ Switching behaviour: pnp or npn ▪ Max. load 250 mA

13.3 Power supply

Supply voltage range	18 to 30 V _{DC} (SELV, PELV, Class 2)
Power consumption	Max. 3 W [w/o outputs IO1 and IO2, 120 mA (+ 2× 250 mA with I/Os)]

13.4 Performance characteristics

Volume flow measurement	
Maximum measured error	±0.8 % o.r.±0.2 % o.f.s.
Repeatability	±0.2 % o.r.
Response time	The response time depends on the configuration (damping).
Medium temperature measurement	
Maximum measured error	±2.5 °C
Repeatability	±0.5 °C
Conductivity measurement	
Repeatability	±5 %o.r.±5 µS/cm

13.5 Installation

→  13

13.6 Environment

Ambient temperature range	-10 to +60 °C (+14 to +140 °F)
Storage temperature	-25 to +85 °C (-13 to +185 °F)
Degree of protection	IP65/67, pollution degree 3
Humidity and moisture	Suitable for indoor environments with up to 100% rh (wet and damp locations)
Operating altitude	up to 2 000 m
Shock resistance	20 g (11 ms) in accordance with IEC/EN60068-2-27
Vibration resistance	Acceleration up to 5 g (10 to 2 000 Hz) in accordance with IEC/EN60068-2-6
Electromagnetic compatibility (EMC)	According to IEC/EN61326 and/or IEC/EN55011 (Class A)

13.7 Process

Medium temperature range	<ul style="list-style-type: none"> ■ -10 to +70 °C (+14 to +158 °F) ■ Permissible short-term temperature, maximum one hour: 85 °C (185 °F) Repetition after 4 hours at the earliest
Medium properties	Liquid, conductivity > 10 µS/cm
Pressure	Max. 16 bar _{rel}

13.8 Mechanical construction

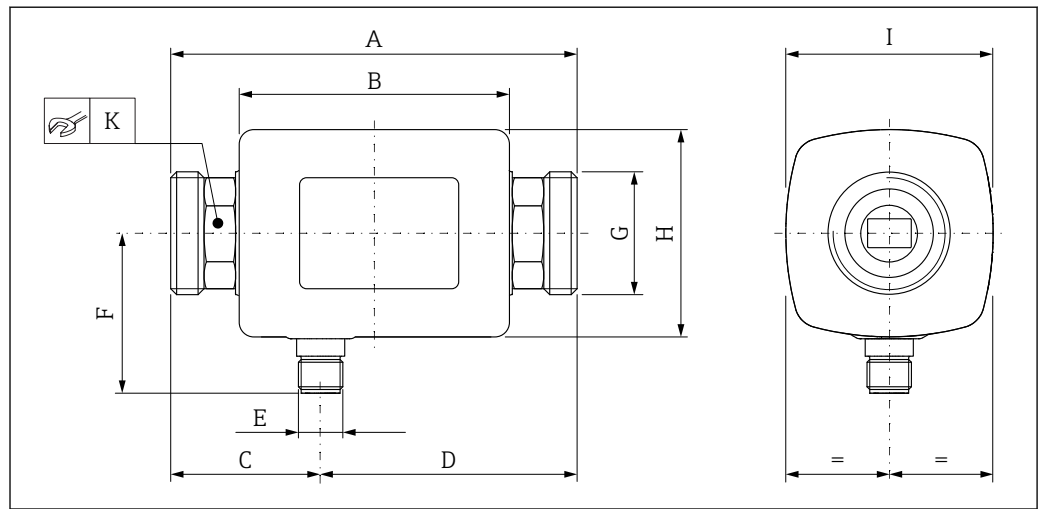

A0033012

Dimensions in SI units

DN	A [mm]	B [mm]	C [mm]	D [mm]	E	F [mm]	G	H [mm]	I [mm]	K [mm]
15	110	73	40.5	69.5	M12 × 1.43	43	G½"	56	56	24
20	110	73	40.5	69.5	M12 × 1.43	43	G¾"	56	56	27
25	110	73	40.5	69.5	M12 × 1.43	43	G1"	56	56	27
50	200	113	80	120	M12 × 1.58	58	G2"	86	86	52

Dimensions in US units

DN	A [in]	B [in]	C [in]	D [in]	E	F [in]	G	H [in]	I [in]	K [mm]
15	4.33	2.87	1.59	2.74	M12 × 1.43	43	G½"	2.2	2.2	24
20	4.33	2.87	1.59	2.74	M12 × 1.43	43	G¾"	2.2	2.2	27

DN	A [in]	B [in]	C [in]	D [in]	E	F [in]	G	H [in]	I [in]	K [mm]
25	4.33	2.87	1.59	2.74	M12 × 1 43		G1"	2.2	2.2	27
50	7.87	4.45	3.15	4.72	M12 × 1 58		G2"	3.39	3.39	52

Weight in SI units

DN	[kg]
15	0.34
20	0.35
25	0.36
50	1.55

Weight in US units

DN	Weight [lbs]
15	0.75
20	0.77
25	0.79
50	3.42

Materials

Component	Material
Measuring tube	PEEK
Electrodes, temperature sensor	1.4435/316L
Process connection	1.4404/316L
Housing	1.4404/316L, 1.4409/CF3M
Seal	FKM
Display window	Polycarbonate

13.9 Operability

Local display

The device has an onsite display:

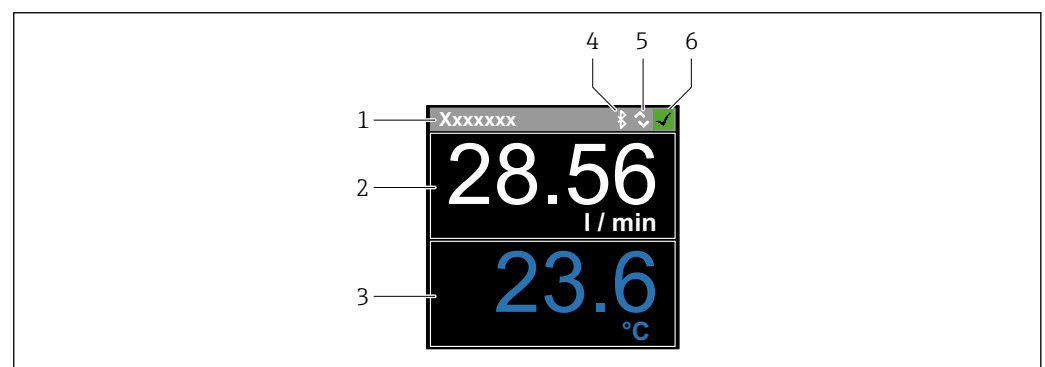

A0032991

- 1 Tag name (configurable)
- 2 Measured variable 1 (configurable), with sign
- 3 Measured variable 2 (configurable), with sign
- 4 Active Bluetooth connection
- 5 Active I/O-Link connection
- 6 Device status

Display element

4 measured variables can be displayed (volume flow, temperature, totalizer, conductivity).

Operation

- Via Bluetooth® wireless technology
- Via IO-Link

Digital communication

Via IO-Link

SmartBlue app

The device has a *Bluetooth*® wireless technology interface and can be operated and configured using the SmartBlue app.

- The range under reference conditions is 10 m (33 ft)
- Incorrect operation by unauthorized persons is prevented by means of encrypted communication and password encryption.
- The *Bluetooth*® wireless technology interface can be deactivated.

13.10 Certificates and approvals



 Currently available certificates and approvals can be called up via the product configurator.

CE mark

The device meets the legal requirements of the applicable EU Directives. These are listed in the corresponding EU Declaration of Conformity along with the standards applied.

Radio approval

The measuring device has radio approval.

 For detailed information regarding radio approval, see appendix →  45

Pressure Equipment Directive

Devices not bearing this marking (PED) are designed and manufactured according to good engineering practice. They meet the requirements of Article 4 paragraph 3 of the Pressure Equipment Directive 2014/68/EU. The range of application is indicated in tables 6 to 9 in Annex II of the Pressure Equipment Directive 2014/68/EU.

cUL_{US} listing

The measuring device is UL-listed.

14 Appendix

14.1 Radio approvals

14.1.1 Europe

This device meets the requirements of the Telecommunications Directive RED 2014/53/EU:

- EN 300 328 V2.1.1
- EN 301 489-1 V1.9.2
- EN 301 489-17 V2.2.1
- EN 62311: 2008

14.1.2 Canada and USA

English

This device complies with Part 15 of the FCC Rules and with Industry Canada licence-exempt RSS standard(s).

Operation is subject to the following two conditions:

- This device may not cause harmful interference, and
- This device must accept any interference received, including interference that may cause undesired operation.

 Changes or modifications made to this equipment not expressly approved by Flowtec AG may void the user's authorization to operate this equipment.

Français

Le présent appareil est conforme aux CNR d'industrie Canada applicables aux appareils radio exempts de licence.

L'exploitation est autorisée aux deux conditions suivantes :

- L'appareil ne doit pas produire de brouillage, et
- L'utilisateur de l'appareil doit accepter tout brouillage radioélectrique subi, même si le brouillage est susceptible d'en compromettre le fonctionnement.

 Les changements ou modifications apportées à cet appareil non expressément approuvée par Flowtec AG peut annuler l'autorisation de l'utilisateur d'opérer cet appareil.

14.1.3 India

ETA Certificate No: ETA - 1707/18-RLO(NE)

14.1.4 Singapore

Complies with
IMDA Standards
DA 103787

A0035905

Complies with IMDA Standards

DA 103787

14.1.9 South Korea

KC 인증

적합성평가정보

R-C-EH7-Picomag

상호 : 한국엔드레스하우저 주식회사

기자재명칭(모델명): 특정소출력 무선기기(무선데이터통신시스템용무선기기)

/ Picomag

제조국 및 제조국가 : EH Flowtec AG / 프랑스

제조년월 : 제조년월로 표기

*사용자안내문

이 기기는 업무용 환경에서 사용할 목적으로 적합성평가를 받은 기기로서 가정용 환경에서 사용하는 경우 전파간섭의 우려가 있습니다.

14.1.10 Other countries

Other national approvals are available on request.

14.2 IO-Link process data

14.2.1 Data structure

Bit number	119 to 112	111 to 104	103 to 96	95 to 88	87 to 80	79 to 72	71 to 64	63 to 56	55 to 48	47 to 40	39 to 32	31 to 24	23 to 16	15 to 8	7 to 0
Data	Conductivity in $\mu\text{S}/\text{cm}$				Totalizer in l				Volume flow in l/s				Temperature in $\frac{1}{10}^{\circ}\text{C}$		Status
Data type	32-bit single-precision floating-point number (IEEE 754)				32-bit single-precision floating-point number (IEEE 754)				32-bit single-precision floating-point number (IEEE 754)				16-bit two's complement		8-bit

Data structure of the status bits 7 to 0

Bit	Description
0	Switches once per sampling rate
1	Reserved
2	Current status S-Out 1
3	Current status S-Out 2
4	Reserved
5	Reserved
6	Reserved
7	Reserved

14.2.2 Diagnostic information

Diagnostic code		Display text	Coding (hex)	PDValid Validity	Priority
Status NE 107	Diagnostic number				
	-	SYSTEM OK	0x0000	1	1
F	181	COIL CIRC.FAIL.	0x5000	0	2
F	180	TEMP.CIRC.FAIL.	0x5000	0	3
F	201	DECICE FAIL.	0x5000	0	4
F	283	MEMORY FAIL.	0x8C00	0	5
C	446	I/O 1 OVERLOAD	0x180C	1	6
C	447	I/O 2 OVERLOAD	0x180C	1	7
C	485	SIMULATION ACT.	0x8C01	1	8
C	453	FLOW OVERRIDE	0x180D	1	9
S	441	I-OUT 1 RANGE	0x180A	1	10
S	444	U-OUT 1 RANGE	0x1809	1	11
S	443	P-OUT 1 RANGE	0x180B	1	12
S	442	I-OUT 2 RANGE	0x180A	1	13
S	445	U-OUT 2 RANGE	0x1809	1	14
S	962	EMPTY PIPE	0x180E	1	15
S	834	TEMPERAT. RANGE	0x8C20	1	16
S	841	FLOW RANGE	0x8C20	1	17

14.3 IO-Link ISDU parameter list

The individual parts of a parameter description are described in the following section:

Designation	ISDU (dec)	ISDU (hex)	Size (Byte)	Data type	Access	Value range	Factory setting	Range limits
Identification								
Device Tag First 10 characters displayed (starting from left)	0x0018	24	32 (max.)	string	r/w		EH_DMA_XXZZ	
Device Name	0x0012	18	16 (max.)	string	r		Picomag	
Device ID1	0x0009	9	1	uint	r		0x01	
Device ID2	0x000A	10	1	uint	r		0x01	
Device ID3	0x000B	11	1	uint	r		0x00	
Vendor Name	0x0010	16	32 (max.)	string	r		EH	
Vendor ID1	0x0007	7	1	uint	r		0x00	
Vendor ID2	0x0008	8	1	uint	r		0x11	
Device Serial No. e.g. (YMXXXXZZ)	0x0015	21	11 (max.)	string	r		see nameplate	
Firmware Version e.g. 01.00.00	0x0017	23	8 (max.)	string	r			
Order code e.g. DMA15-AAAAA1	0x0102	258	18 (max.)	string	r		see nameplate	
Device Type	0x0100	256	2	uint	r		0x94FF	
Diagnostics								
Actual Diagnostics e.g. C485 (= SIMULATION ACT.)	0x0104	260	4	string	r			
Last Diagnostics e.g. S962 (= EMPTY PIPE)	0x0105	261	4	string	r			
Simulation Proc. Var.	0x015F	351	2	uint	r/w	enable=1 disable=0		
Sim.Proc.Var.Value Volumeflow Unit selection list from Unit Volumeflow	0x0166	358	4	float	r/w		0.0	-10 ⁶ 10 ⁶
Sim.Proc.Var.Value Temperature Unit selection list from Unit Temperature	0x0168	360	4	float	r/w		0.0	-10 ⁴ 10 ⁴
Sim.Proc.Var.Value Conductivity Unit selection list from Unit Conductivity	0x0167	359	4	float	r/w		0.0	0 10 ⁶
Measured Values								
Volumeflow Current volume flow measured value	0x0161	353	4	float	r			
Temperature Current temperature measured value	0x0163	355	4	float	r			
Conductivity Current conductivity measured value	0x0164	365	4	float	r			
Totalizer Current totalizer measured value	0x0169	361	4	float	r/w		0.0	

Designation	ISDU (dec)	ISDU (hex)	Size (Byte)	Data type	Access	Value range	Factory setting	Range limits
System Units								
Unit Volumeflow	0x0226	550	2	uint	r/w	l/s=0 l/h=5 fl. oz/min=4 m ³ /h=1 l/min=2 Usgpm=3	l/min	
Unit Volume	0x0227	551	2	uint	r/w	ml=0 USozf=1 l=2 m ³ =3 Usgal=4	ml	
Unit Temperature	0x0228	552	2	uint	r/w	°C=0 °F=1	°C	
Unit Conductivity	0x0229	553	2	uint	r/w	µS/cm=0 S/m=1 mS/cm=2	µS/cm=0	
Unit Totalizer	0x016B	363	2	uint	r/w	USozf=1 l=2 m ³ =3 Usgal=4 kl=5 Ml=6 kUsg=7	m ³	
Sensor								
Install. Direction In relation to direction of arrow on the device	0x015E	350	2	uint	r/w	forward=0 reverse=1	forward	
Low Flow Cut Off The flow rate below the selected value is zero Unit selection list from Unit Volumeflow	0x0160	352	4	float	r/w		0.4/0.75/1.2/5.0 l/min	0 10 ⁶
Damping Volume flow damping via the PT1 element Unit: s	0x01A4	420	4	float	r/w		0 s	0 100
Output 1								
Operating Mode IO-Link is set if connected to a master	0x01F4	500	2	uint	r/w	P-Out=0 I-Out=1 S-In=2 S-Out=3 IO-Link=4 U-Out=5 off=6	IO-Link	
Current output I-Out 1								
I - OUT Assign	0x0258	600	2	uint	r/w	off=0 volume flow=1 temperature=2 conductivity=4	volume flow	
Q-Start-Value ASP ¹⁾ for volume flow Unit selection list from Unit Volumeflow	0x0259	601	4	float	r/w		0 l/min	-9.9·10 ⁹ 9.9·10 ⁹
Q-End-Value AEP ²⁾ for volume flow Unit selection list from Unit Volumeflow	0x025A	602	4	float	r/w		25/50/100/750 l/min	-9.9·10 ⁹ 9.9·10 ⁹

Designation	ISDU (dec)	ISDU (hex)	Size (Byte)	Data type	Access	Value range	Factory setting	Range limits
T-Start-Value ASP ¹⁾ for temperature Unit selection list from Unit Temperature	0x025F	607	4	float	r/w		-10 °C	-9.9·10 ⁹ 9.9·10 ⁹
T-End-Value AEP ²⁾ for temperature Unit selection list from Unit Temperature	0x0260	608	4	float	r/w		+70 °C	-9.9·10 ⁹ 9.9·10 ⁹
s-Start-Value ASP ¹⁾ for conductivity Unit selection list from Unit Conductivity	0x025D	605	4	float	r/w		0	-9.9·10 ⁹ 9.9·10 ⁹
s-End-Value AEP ²⁾ for conductivity Unit selection list from Unit Conductivity	0x025E	606	4	float	r/w		1000	-9.9·10 ⁹ 9.9·10 ⁹
Pulse output P-Out								
Pulse Value Unit selection list from Unit Volume	0x03E8	1000	4	float	r/w		0.5/1.0/2.0/10.0 ml	10 ⁻⁹ 9.9·10 ⁹
Switch output S-Out 1								
Switch Polarity	0x032B	811	2	uint	r/w	pnp=0 npn=1	pnp	
Switch Function	0x0320	800	2	uint	r/w	alarm=0 off=1 on=2 lim.vol.flow=3, lim.temp.=4 lim.vol.=5 lims=11 win.vol.flow=6 win.temp.=7 win.vol.=8 wins=13 epd=9	alarm	
Q-ON-Value Unit selection list from Unit Volumeflow	0x0321	801	4	float	r/w		20/40/80/600 l/min	-9.9·10 ⁹ 9.9·10 ⁹
Q-OFF-Value Unit selection list from Unit Volumeflow	0x0322	802	4	float	r/w		15/30/60/450 l/min	-9.9·10 ⁹ 9.9·10 ⁹
T-ON-Value Unit selection list from Unit Temperature	0x0327	807	4	float	r/w		+ 60 °C	-9.9·10 ⁹ 9.9·10 ⁹
T-OFF-Value Unit selection list from Unit Temperature	0x0328	808	4	float	r/w		+ 50 °C	-9.9·10 ⁹ 9.9·10 ⁹
V-ON-Value Unit selection list from Unit Totalizer	0x0329	809	4	float	r/w		0.2/0.4/0.8/6.0 m ³	-9.9·10 ⁹ 9.9·10 ⁹
V-OFF-Value Unit selection list from Unit Totalizer	0x032A	810	4	float	r/w		0.15/0.3/0.6/4.5 m ³	-9.9·10 ⁹ 9.9·10 ⁹
s-ON-Value Unit selection list from Unit Conductivity	0x0325	805	4	float	r/w		500	-9.9·10 ⁹ 9.9·10 ⁹

Designation	ISDU (dec)	ISDU (hex)	Size (Byte)	Data type	Access	Value range	Factory setting	Range limits
s-OFF-Value Unit selection list from Unit Conductivity	0x0326	806	4	float	r/w		200	-9.9·10 ⁹ 9.9·10 ⁹
Voltage output U-Out 1								
U - OUT Assign	0x02BC	700	2	uint	r/w	off=0 volume flow=1 temperature=2 conductivity=4	volume flow	
Q-Start-Value ASP ¹⁾ for volume flow Unit selection list from Unit Volumeflow	0x02BD	701	4	float	r/w		0 l/min	
Q-End-Value AEP ²⁾ for volume flow Unit selection list from Unit Volumeflow	0x02BE	702	4	float	r/w		25/50/100/750 l/min	
T-Start-Value ASP ¹⁾ for temperature Unit selection list from Unit Temperature	0x02C3	707	4	float	r/w		-10 °C	
T-End-Value AEP ²⁾ for temperature Unit selection list from Unit Temperature	0x02C4	708	4	float	r/w		+70 °C	
s-Start-Value ASP ¹⁾ for conductivity Unit selection list from Unit Conductivity	0x02C1	705	4	float	r/w		0 µS/cm	
s-End-Value AEP ²⁾ for conductivity Unit selection list from Unit Conductivity	0x02C2	706	4	float	r/w		1000 µS/cm	

Designation	ISDU (dec)	ISDU (hex)	Size (Byte)	Data type	Access	Value range	Factory setting	Range limits
Digital input D-In 1								
D-IN Polarity	0x0385	901	2	uint	r/w	low=0 high=1	high	
D-IN Function	0x0384	900	2	uint	r/w	off=0 res.tot.=1 zero ret.=2	res.tot.	
IO-Link								
IO-LINK Vendor Name	0x0010	16	32 (max.)	string	r		EH	
IO-LINK Product Name	0x0012	18	16 (max.)	string	r		Picomag	
IO-LINK RevisionID	0x0004	4	1	uint	r		0x11	
Output 2								
Operating Mode	0x01F5	501	2	uint	r/w	I-Out=1 S-In=2 S-Out=3 U-Out=5 off=6	Off	
Current output I-Out 2								
I - OUT Assign	0x028A	650	2	uint	r/w	off=0 volume flow=1 temperature=2	temperature	
Q-Start-Value ASP ¹⁾ for volume flow Unit selection list from Unit Volumeflow	0x028B	651	4	float	r/w		0 l/min	
Q-End-Value AEP ²⁾ for volume flow Unit selection list from Unit Volumeflow	0x028C	652	4	float	r/w		25/50/100/750 l/min	
T-Start-Value ASP ¹⁾ for temperature Unit selection list from Unit Temperature	0x0291	657	4	float	r/w		-10 °C	
T-End-Value AEP ²⁾ for temperature Unit selection list from Unit Temperature	0x0292	658	4	float	r/w		+70 °C	
s-Start-Value ASP ¹⁾ for conductivity Unit selection list from Unit Conductivity	0x028F	655	4	float	r/w		0	-9.9·10 ⁹ 9.9·10 ⁹
s-End-Value AEP ²⁾ for conductivity Unit selection list from Unit Conductivity	0x0290	656	4	float	r/w		1000	-9.9·10 ⁹ 9.9·10 ⁹

Designation	ISDU (dec)	ISDU (hex)	Size (Byte)	Data type	Access	Value range	Factory setting	Range limits
Switch output S-Out 2								
Switch Polarity	0x035D	861	2	uint	r/w	pnp=0 npn=1	pnp	
Switch Function	0x0352	850	2	uint	r/w	alarm=0 off=1 on=2 lim.vol.flow=3 lim.temp.=4 lim.vol.=5, win.vol.flow=6 lims=11 win.temp.=7 win.vol.=8 wins=13 epd=9	alarm	
Q-ON-Value Unit selection list from Unit Volumeflow	0x0353	851	4	float	r/w		20/40/80/600 l/min	
Q-OFF-Value Unit selection list from Unit Volumeflow	0x0354	852	4	float	r/w		15/30/60/450 l/min	
T-ON-Value Unit selection list from Unit Temperature	0x0359	857	4	float	r/w		+ 60 °C	
T-OFF-Value Unit selection list from Unit Temperature	0x035A	858	4	float	r/w		+ 50 °C	
V-ON-Value Unit selection list from Totalizer	0x035B	859	4	float	r/w		0.2/0.4/0.8/6.0 m ³	
V-OFF-Value Unit selection list from Totalizer	0x035C	860	4	float	r/w		0.15/0.3/0.6/4.5 m ³	
s-ON-Value Unit selection list from Conductivity	0x0357	855	4	float	r/w		500	
s-OFF-Value Unit selection list from Conductivity	0x0358	856	4	float	r/w		200	
Voltage output U-Out 2								
U - OUT Assign	0x02EE	750	2	uint	r/w	off=0 volume flow=1 temperature=2	temperature	
Q-Start-Value ASP ¹⁾ for volume flow Unit selection list from Unit Volumeflow	0x02EF	751	4	float	r/w		0 l/min	
Q-End-Value AEP ²⁾ for volume flow Unit selection list from Unit Volumeflow	0x02F0	752	4	float	r/w		25/50/100/750 l/min	
T-Start-Value ASP ¹⁾ for temperature from Unit Temperature	0x02F5	757	4	float	r/w		-10 °C	
T-End-Value AEP ²⁾ for temperature from Unit Temperature	0x02F6	758	4	float	r/w		+70 °C	

Designation	ISDU (dec)	ISDU (hex)	Size (Byte)	Data type	Access	Value range	Factory setting	Range limits
s-Start-Value ASP ¹⁾ for temperature from Conductivity	0x02F3	755	4	float	r/w		0 µS/cm	
s-End-Value AEP ²⁾ for temperature from Conductivity	0x02F4	756	4	float	r/w		1000 µS/cm	
Digital input D-In 2								
D-IN Polarity	0x0395	917	2	uint	r/w	low=0 high=1	high	
D-IN Function	0x0394	916	2	uint	r/w	off=0 res.tot.=1 zero ret.=2	res.tot.	
Device info								
Device Name								
Device Tag								
Device Serial No.								
Firmware Version								
Order code								
Display								
Display Layout	0x01C3	451	2	uint	r/w	QV=0 QT=1 Qs=3 VT=2, Vs=4 Ts=5 QVTs=6 QVTs_m=7	QT	
Display Rotation	0x01C4	452	2	uint	r/w	0 °=0 90 °=1 180 °=2 270 °=3 auto=4	Auto	
Display Backlight	0x01C2	450	2	uint	r/w	0 - 100	50	
Bluetooth configuration								
Bluetooth Function	0x041A	1050	2	uint	r/w	on=1 off=0	On	
Bluetooth Tx Pwr Level	0x041B	1051	2	uint	r	0 - 4		
Bluetooth Conn. Status	0x041C	1052	1	uint	r			
Administration								
Set Access Code Define access code	0x0108	264	2	uint	w		0000	
Access Code Enter access code	0x0107	263	2	uint	w			
Reset Device	0x010E	270	2	uint	w	cancel=0 restore fact.=1 restart=4	cancel	

Designation	ISDU (dec)	ISDU (hex)	Size (Byte)	Data type	Access	Value range	Factory setting	Range limits
Product Specific Process Values								
Status IO 1	0x0386	902	2	uint	r	low=0 high=1		
Status IO 2	0x0396	918	2	uint	r	low=0 high=1		

- 1) Analog Start Point
- 2) Analog End Point

Index

A

About this document	5
Accessories	39
Appendix	45
Application	
Media	7

B

Basic safety instructions	7
Bidirectional flow measurement (Q), temperature measurement (T)	24, 27

C

CE mark	8, 44
Commissioning	21
Configuring system units	22
Configuring the current output	23
Configuring the display	29
Configuring the IO modules	23
Configuring the measuring device	21
Configuring the pulse output	24
Configuring the status input	28
Configuring the voltage output	26
Connecting the measuring device	18
Connection conditions	15
Current output configuration version	16
Current version data for the device	20

D

Data management	30
Declaration of Conformity	8
Designated use	7
Device information	38
Device master file	20
Diagnostic behavior	36
Diagnostic information on local display	36
Diagnostic message	36
Diagnostics and troubleshooting	35
Dimensions in SI units	42
Document function	5
Documentation	6

E

Electrical connection	15
---------------------------------	----

F

Field of application	
Residual risks	7
Firmware history	38

I

Identification	21
Identifying the measuring device	10
Incoming acceptance	10
Inlet and outlet runs	13
Inspection	
Received goods	10

Installation	13
Installation conditions	13
IO-Link configuration version	17

M

Materials	43
Mounting location	13
Mounting position	13
Mounting the measuring device	13

O

Operation options	19
SmartBlue app	19
Operational	33
Operational safety	8
Overview of device description files	20
Overview of diagnostic events	37
Overview of the operating menu	21

P

Packaging disposal	12
Pending diagnostic events	31
Pin assignment, device plug	15
Post-connection check	18
Pressure Equipment Directive	44
Product safety	8

R

Radio approval	44
Radio approvals	45
Registered trademarks	6
Requirements for connecting cables	15
Requirements for personnel	7

S

Security	30
Setting the installation direction and measurement	22
Status input configuration version	17
Status signals	36
Storage conditions	12
Storage temperature	12
Switch output configuration version	16
Switch/pulse output configuration version	16
Switching ON the measuring device	21
Symbols used	5
System integration	20

T

Technical data	41
Certificates and approvals	44
Environment	42
Input	41
Installation	41
Mechanical construction	42
Operability	43
Output	41
Performance characteristics	41

Power supply	41
Process	42
Temperature range	
Storage temperature	12
Tools	
Transport	12
Totalizer	28
Transporting the measuring device	12
Troubleshooting	
General	35
U	
Unidirectional flow measurement (Q), conductivity measurement	24, 27
Using the measuring device	
Borderline cases	7
Incorrect use	7
V	
Voltage output configuration version	17
W	
W@M Device Viewer	10
Weight	
Transport (notes)	12
Weight in SI units	43
Weight in US units	43
Workplace safety	7