

Unique Surface Probes



All the probes in this series meet the Standard Limits of Error.

Model No. 88106(*)

Right-angle probe for fast response times. Sheath length is 102 mm (4"). Max surface temperature is 760°C (1400°F).

Replaceable Element not supplied, order Model No. 88106(*)-RE

Model No. 88107(*)

Right-angle, long reach probe with fast response design. Sheath length is 203 mm (8"), with 760°C (1400°F) max surface temperature.

Replaceable Element not supplied, order Model No. 88107(*)-RE

All models shown smaller than actual size.

Model No. 88108(*)

Right-angle, long 300 mm (12") reach probe with fast response design. 760°C (1400°F) max surface temperature.

Replaceable Element not supplied, order Model No. 88108(*)-RE

Model No. 88010(*)

Long, 300 mm (12") reach version of the 88006. Fast response design with 760°C (1400°F) max surface temperature for use in oven and furnaces.

Replaceable Element not supplied, order Model No. 88010(*)-RE

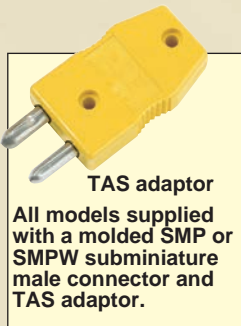

TAS adaptor

All models supplied with a molded SMP or SMPW subminiature male connector and TAS adaptor.

For a male straight M8 plug add "M8-S-M" to the model number and additional cost to the price, for a male straight M12 plug add "M12-S-M" to the model number and additional cost to the price.

For a male right-angled M8 plug add "M8-R-M" to the model number and additional cost to the price, for a male right-angled M12 plug add "M12-S-M" to the model number and additional cost to the price.



For Temperatures up to 760° C (1400°F)

* Specify Calibration:

K: CHROME^Ω™-ALOME^Ω™

E: CHROME^Ω™-Constantan

Visit us online for dimensions.

Ordering Example:

88018K, Type K surface probe.

Model No. 88007(*)

Miniature, fast response probe. Ideal for measuring the surface temperature of small electronic parts. 250°C (480°F) max surface temperature.

Replaceable Element supplied free, for additional elements order Model No. 88007(*)-RE

Model No. 88006(*)

Miniature, fast response probe with 480°C (900°F) max surface temperature. Ideal for surface temperatures of small electronic parts.

Replaceable Element not supplied, Model No. 88006(*)-RE

All models shown smaller than actual size.

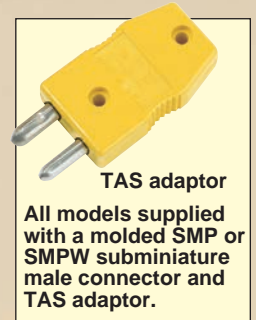

TAS adaptor

All models supplied with a molded SMP or SMPW subminiature male connector and TAS adaptor.

Model No. 88016(*)

Visit us online for dimensions.

High temperature, right-angle probe, with miniature pencil type head. Best suited to stationary surfaces, with sensing head parallel to the handle. 480°C (900°F) max surface temperature.

Replaceable Element not supplied, order Model No. 88016(*)-RE



Miniature connector.

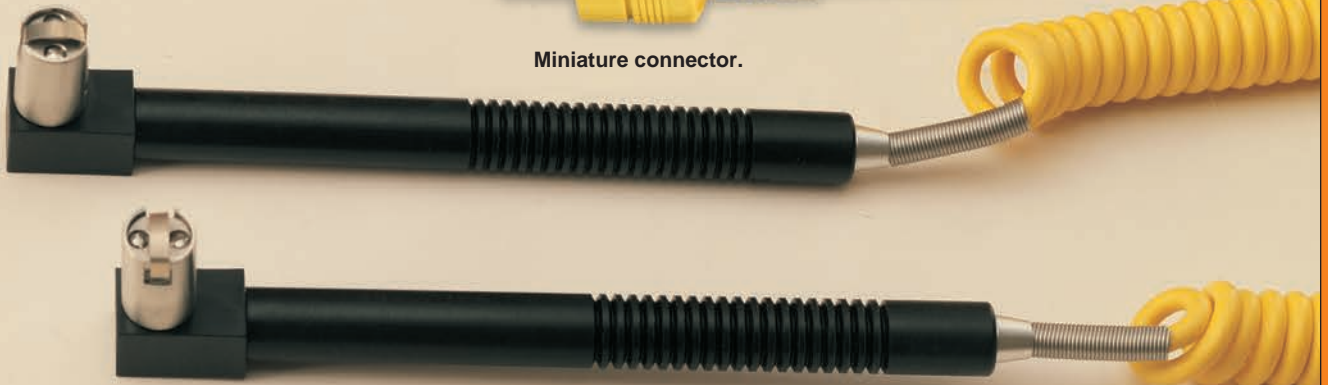

Model No. 88026(*)

High temperature, right-angle probe, with miniature pencil type head. Best suited to stationary surfaces, with sensing head perpendicular to the handle. 480°C (900°F) max surface temperature.

Replaceable Element not supplied, order Model No. 88026(*)-RE

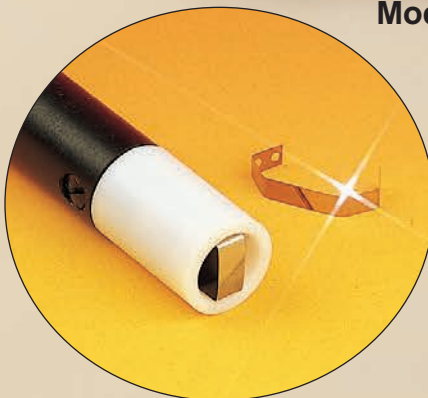

Model No. 88007K and replaceable element, Model No. 88007K-RE.

* Specify calibration: K - Type K Thermocouple E - Type E Thermocouple
Ordering Example: 88007K probe with type K Thermocouple.

Replaceable Element Design

Customer Replaceable Element: Probe is supplied with one additional element.

Factory Replaceable Element: OMEGA™ can install replaceable elements and check the probe for an additional cost, with the first replacement free! For non-replaceable element probes, replacement probes are available with a one time trade-in discount. Please contact our Customer Service Department for details.

To order Replaceable Elements, add suffix "-RE" to model number.

Ordering Example: 88026K-RE for 88026K probe.

* Insert calibration needed, e.g. K (Type K thermocouple).

Unique Surface Probes Series 88000

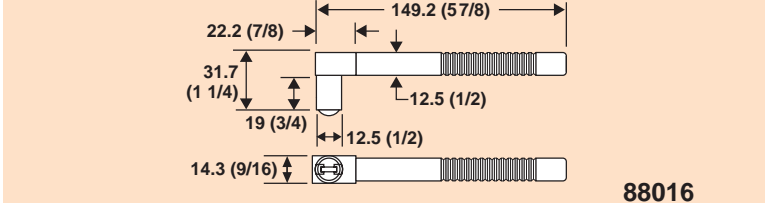
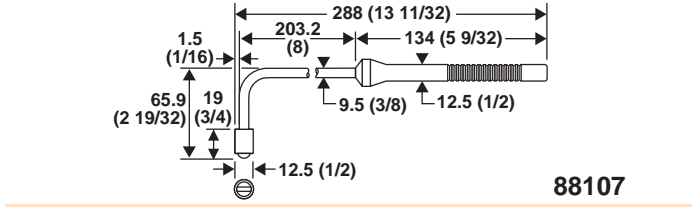
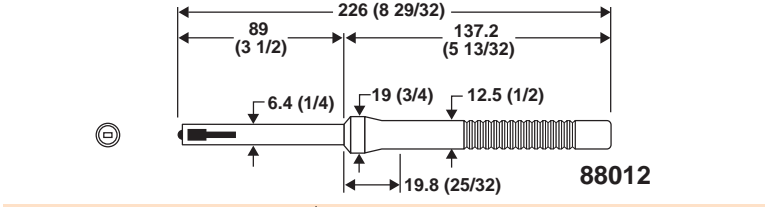
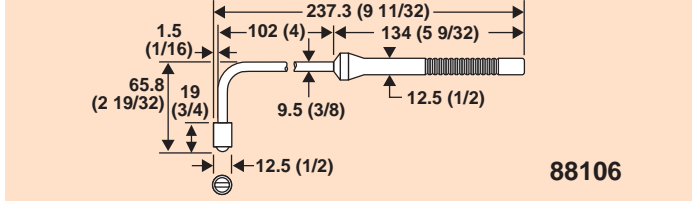
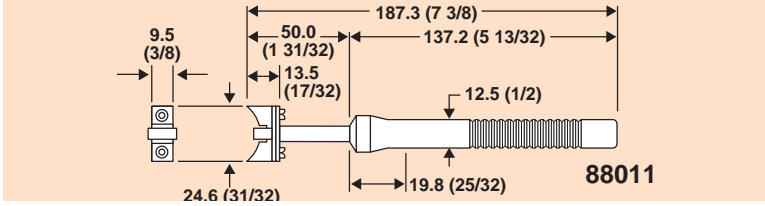
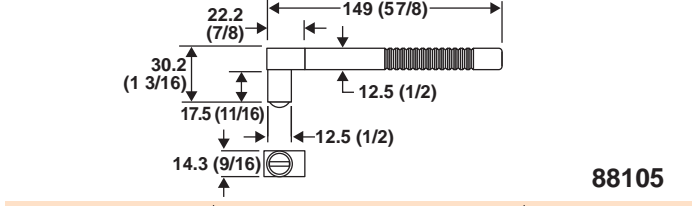
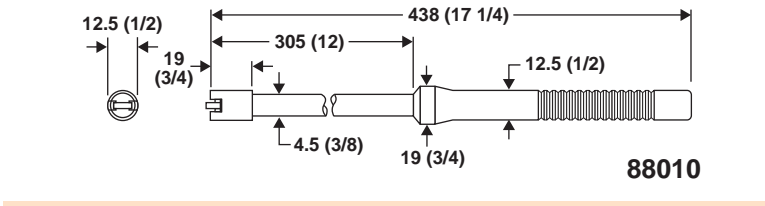
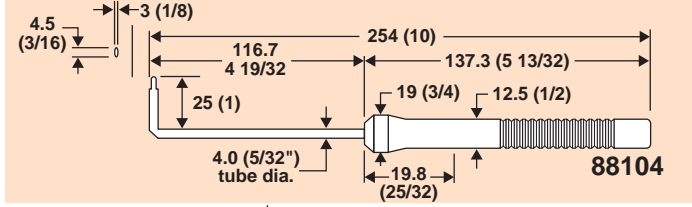
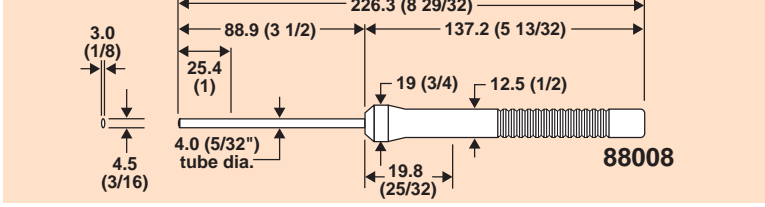
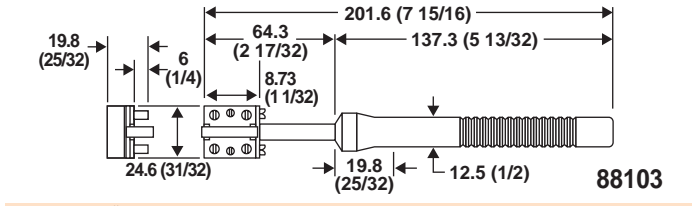
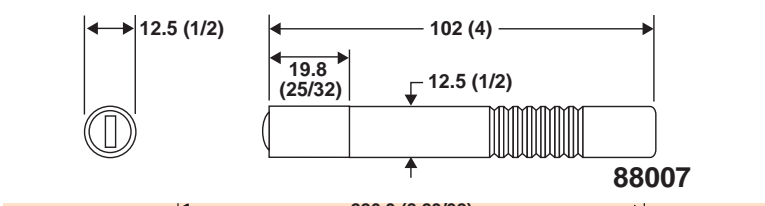
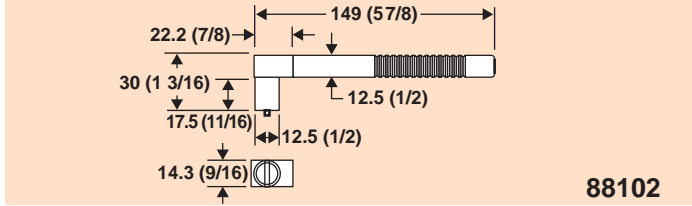
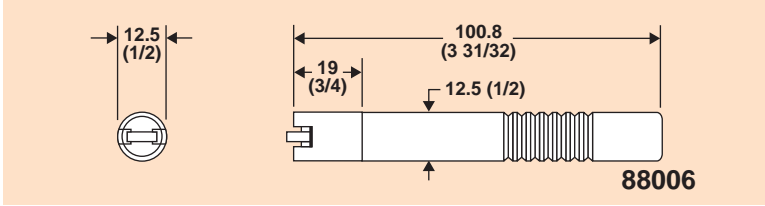
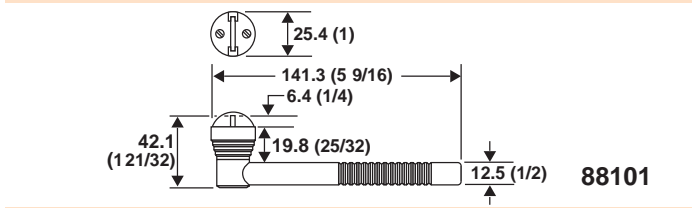
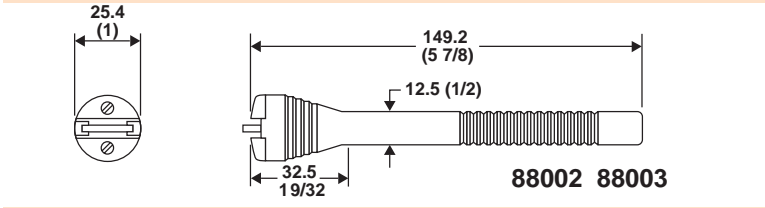
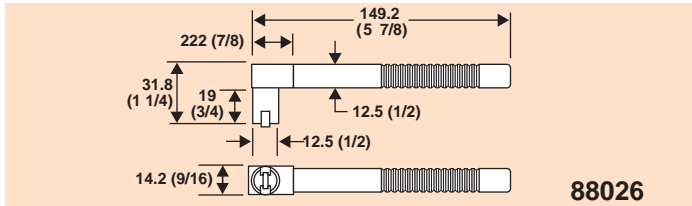
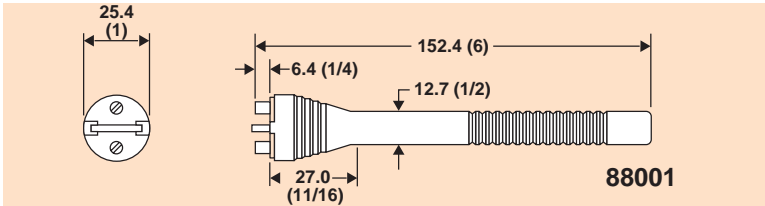

Dimensions: mm (in)

Unique Surface Probes Series 88000/98000

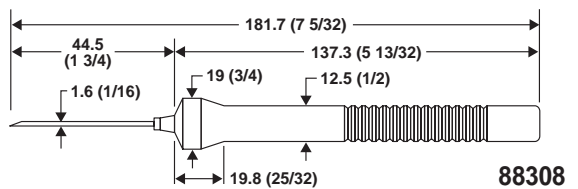
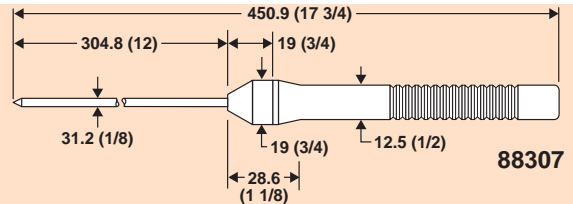
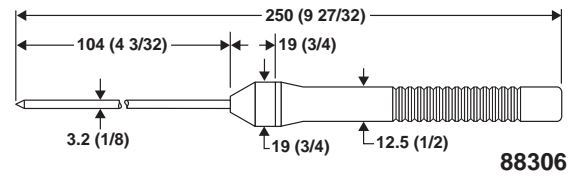
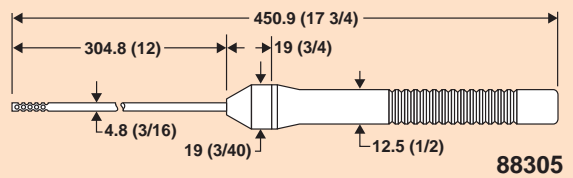
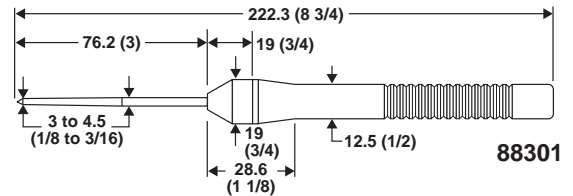
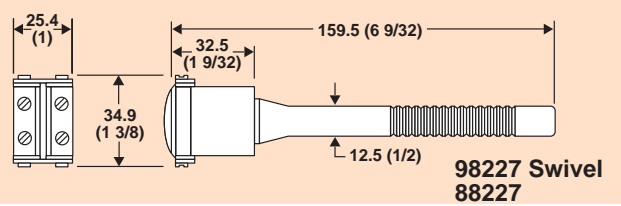
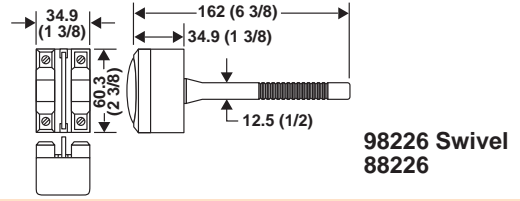
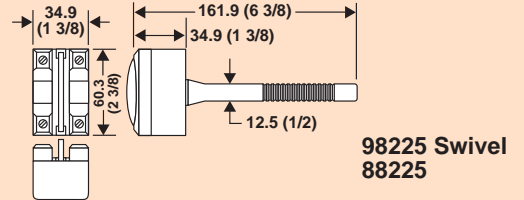
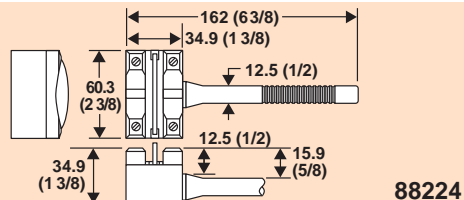
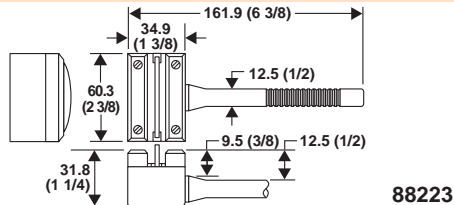
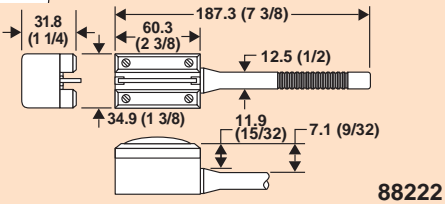
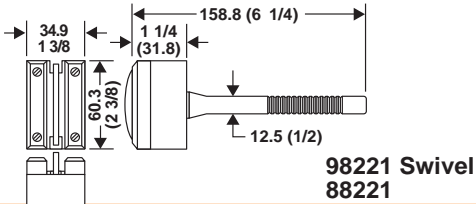
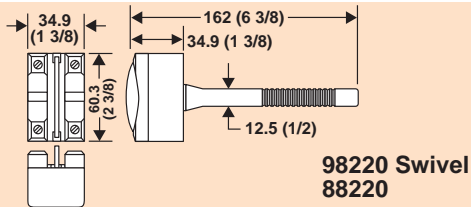
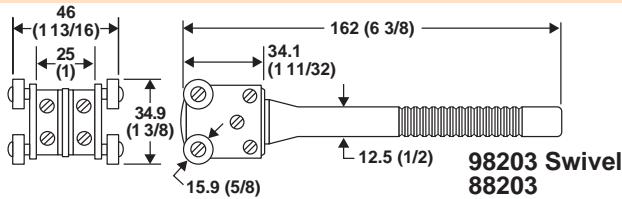
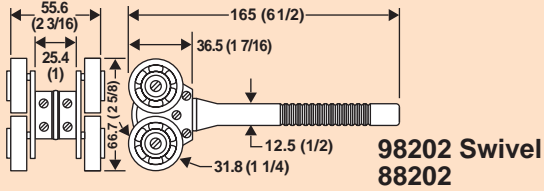
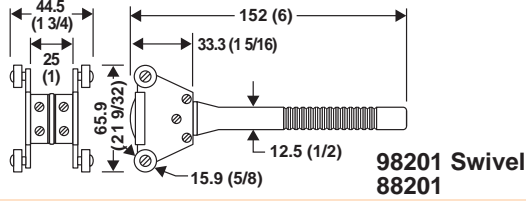
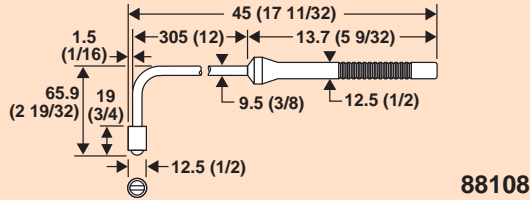

Dimensions: mm (in)

Model 88009

1.5 (0.06) Max. Element Deflection

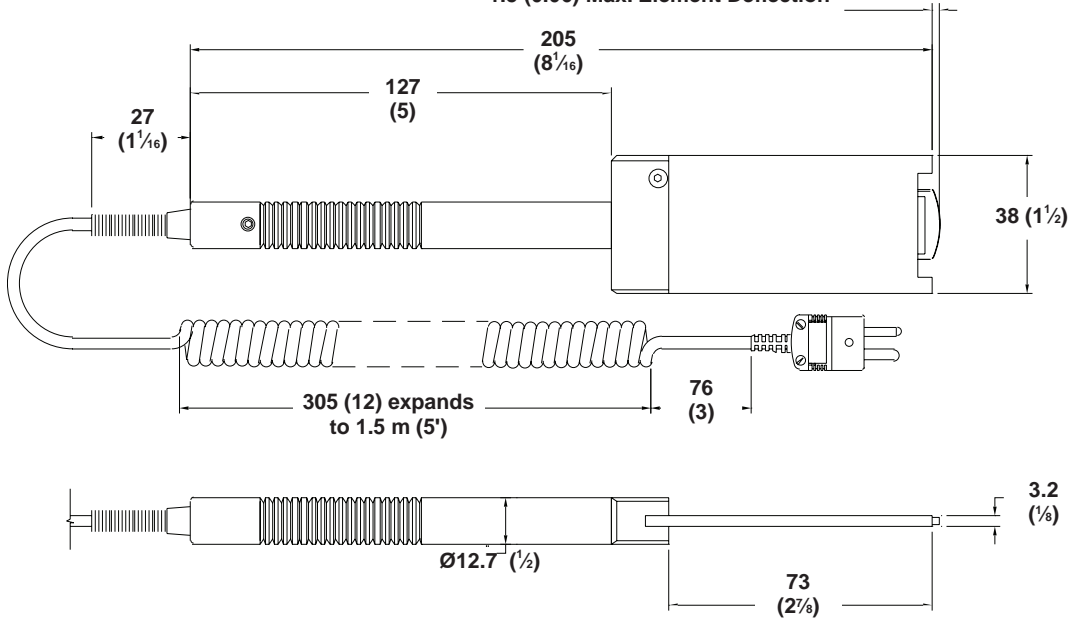

Model 88014

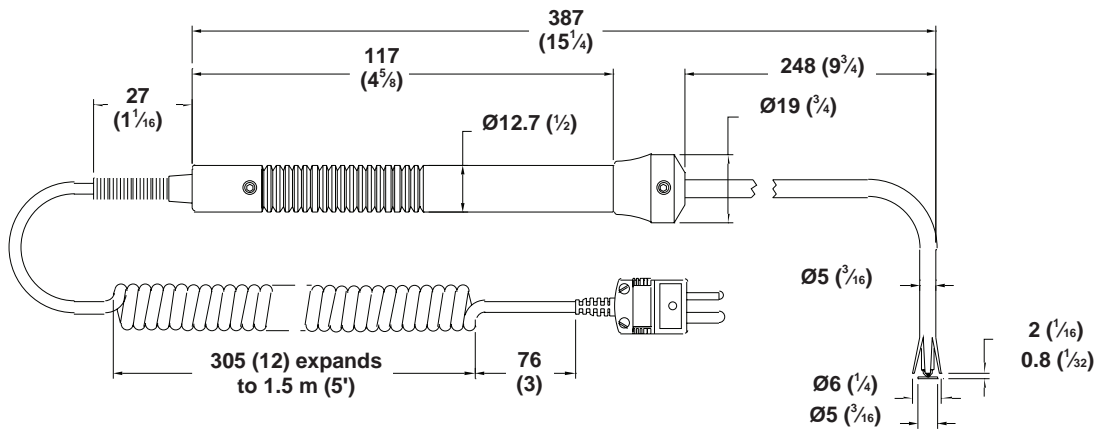

Model 88013

