

**1 YEAR**  
WARRANTY



# **Ω OMEGA™** **User's Guide**



***Shop online at  
omega.com***

***e-mail: info@omega.com  
For latest product manuals:  
www.omegamanual.info***

## SP-016

# Heat Flux Thermopile Smart Probe



omega.com info@omega.com

**Servicing North America:**

**U.S.A.**

**Headquarters:**

Omega Engineering, Inc.

800 Connecticut Ave. Suite 5N01, Norwalk, CT 06854

Toll-Free: 1-800-826-6342 (USA & Canada only)

Customer Service: 1-800-622-2378 (USA & Canada only)

Engineering Service: 1-800-872-9436 (USA & Canada only)

Tel: (203) 359-1660

Fax: (203) 359-7700

e-mail: info@omega.com

# Table of Contents

<b>1</b>	<b>Notes Cautions and Warnings</b>	<b>5</b>
<b>2</b>	<b>Introduction</b>	<b>6</b>
<b>3</b>	<b>Hardware Setup</b>	<b>7</b>
3.1	Connecting your Layer N Smart Interface	7
3.2	Heat Flux Sensor Wiring Diagram	7
<b>4</b>	<b>SYNC Configuration</b>	<b>7</b>
4.1	Connecting to SYNC - Automatic Detect	7
4.2	Connecting to SYNC – Manual	7
4.2.1	Communication Interface	8
4.3	Heat Flux Interface	9
4.4	Thermocouple Configuration	10
4.5	Cold Junction Calibration	11
4.6	Configurable Digital I/O	12
4.6.1	Input Settings	12
4.6.2	Output Settings	12
4.6.2.1	ON/OFF Functions	13
4.6.2.2	Pulse-Width Modulation (PWM)	13
4.6.3	Setting Alarms	13
4.6.4	ON/OFF Control	14
<b>5</b>	<b>Appendix: SP-016 Registers</b>	<b>15</b>
<b>5.1</b>	<b>Heat Flux Input Descriptor</b>	<b>15</b>
5.1.1	Heat Flux Measurement Types	15
5.1.2	Heat Flux Input Data Type/Format	15
5.1.2.1	Data Type	16
5.1.2.2	Factory Calibrate	16
5.1.2.3	Sensor Writeable	16
5.1.2.4	Smart Sensor	16
5.1.3	Heat Flux Input Configuration	16
5.1.3.1	Apply Scaling	16
5.1.3.2	Lock	16
5.1.3.3	Assigned	16
5.1.3.4	Available	16
5.1.4	Heat Flux Sensor I/O Byte	16
5.1.5	Heat Flux Sensor Parameters	17
5.1.6	Heat Flux User Calibration Parameters	17
5.1.7	IPSO Digital Input Sensor Definition	17
5.1.7.1	Sensor Trigger Function	18
<b>5.2</b>	<b>Thermocouple Descriptor</b>	<b>18</b>
5.2.1	Thermocouple Measurement Types	18
5.2.2	Thermocouple Input Data Type/Format	19
5.2.2.1	Data Type	19
5.2.2.2	Factory Calibrate	19
5.2.2.3	Sensor Writeable	19
5.2.2.4	Smart Sensor	19
5.2.3	Thermocouple Input Configuration	19
5.2.3.1	Sensor Type / Range	19
5.2.3.2	Apply Scaling	20
5.2.3.3	Lock	20
5.2.3.4	Assigned	20

5.2.3.5	Available.....	20
5.2.4	Thermocouple Sensor Device Byte .....	20
5.2.5	Thermocouple User Calibration Parameter .....	20
5.2.6	IPSO Thermocouple Temperature Sensor Definition.....	21
5.2.6.1	Sensor Trigger Function .....	21
<b>5.3</b>	<b>Digital Input / Output Descriptor .....</b>	<b>22</b>
5.3.1	DIO Sensor Type .....	22
5.3.2	DIO Data Type/Format .....	22
5.3.2.1	Data Type .....	22
5.3.2.2	Factory Calibrate .....	22
5.3.2.3	Sensor Writeable .....	22
5.3.2.4	Smart Sensor .....	22
5.3.3	DIO Input Configuration .....	22
5.3.3.1	Lock .....	23
5.3.3.2	Apply Scaling .....	23
5.3.3.3	Assigned .....	23
5.3.3.4	Available.....	23
5.3.4	DIO Device Configuration .....	23
5.3.4.1	Invert.....	23
5.3.4.2	Enable .....	23
5.3.5	DIO IPSO Definition .....	23
5.3.5.1	Sensor Trigger Function .....	24
5.3.6	DIO Input Circuitry.....	24
<b>5.4</b>	<b>Outputs .....</b>	<b>25</b>
5.4.1	PWM Rate.....	25
5.4.2	Active State.....	25
5.4.3	Output Drive.....	25
5.4.4	Output Type.....	25
<b>6</b>	<b>Specifications .....</b>	<b>26</b>



# 1 Notes Cautions and Warnings

If the equipment is used in a manner not specified in this manual, the protection by the equipment may be impaired.

Do not operate the equipment in flammable or explosive environments.

It is important to read and follow all precautions and instructions in this manual before operating or commissioning this device as it contains important information relating to safety and EMC. Failure to follow all the safety precautions may result in injury and/or damage to your equipment.

The following labels identify information that is especially important to note:

-  **Note:** Provides you with information that is important to successfully setup and use the SP-016.
-  **Caution or Warning:** Tells you about the risk of electrical shock.
-  **Caution, Warning, or Important:** Tells you of circumstances that can affect the functionality of the instrument and must refer to accompanying documents.

## 2 Introduction

The Layer N SP-016 Heat Flux Smart Probe provides an easy way to integrate your thermopile-based heat flux sensor to the Layer N Ecosystem. The SP-016 performs the necessary calculations to provide the heat flux measurement in  $W/m^2$ . The SP-016 accepts heat flux sensors through its M12 4-pin connector and Layer N Smart Interfaces through its M12 8-pin connector. The optional M12-S-M-FM connector can be utilized to easily connect wire leads typically found on heat flux sensors to your SP-016. The SP-016 supports any single thermopile sensor input ( $mV/W/m^2$ ) and an additional thermocouple input for temperature compensation.

The Layer N SP-016 features 2 configurable digital I/O pins. These can be used for a myriad of applications including driving relays, physical alarms, or sensing dry contacts like door switches. The SP-016 can also be utilized as an edge controller, with autonomous independent decision-making capabilities to generate local alarms or provide control outputs based on sensor inputs.

### Included with your SP-016

- SP-016 Unit
- Quick Start Guide

### Additional Material Needed

- Layer N Smart Interface
- Computer with Windows OS
- SYNC configuration software
- Heat Flux Sensor (HFS-05)

### Optional Materials

- M12-S-M-FM Screw Terminal Accessory



## 3 Hardware Setup

### 3.1 Connecting your Layer N Smart Interface

The SP-016 requires a Layer N Smart Interface to connect to your computer. Use the M12 8-Pin Connector diagram below to connect your SP-016 to your Layer N Smart Interface.

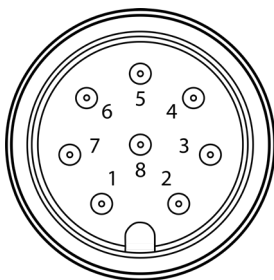

M12 8-Pin Connector

Pin	Name	Function
Pin 1	DIO 0	Discrete I/O Signal 0
Pin 2	INTR	Interrupt Signal
Pin 3	SCL	I2C Clock Signal
Pin 4	SDA	I2C Data Signal
Pin 5	Shield	Shield Ground
Pin 6	DIO 1	Discrete I/O Signal 1
Pin 7	GND	Power Ground
Pin 8	3.3VDD	Power Supply

### 3.2 Heat Flux Sensor Wiring Diagram

The Layer N SP-016 accepts digital pulse inputs through its M12 4-Pin connector. If you are connecting wire directly to the SP-016, view the wiring diagrams provided below:

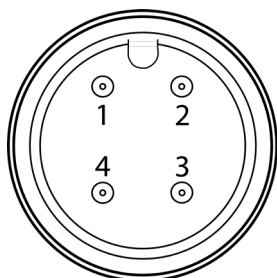

M12 5-Pin Connector

Pin	Thermocouple TempCO
Pin 1	TC-
Pin 2	Thermopile +
Pin 3	Thermopile -
Pin 4	TC +

## 4 SYNC Configuration

Layer N Smart Probe products are easily configurable through SYNC configuration software. Ensure SYNC is running on your Windows OS computer before continuing. Connect your SP-016 to your computer through your Layer N Smart Interface.

**Note** SYNC is available to download for free on the OMEGA website.

### 4.1 Connecting to SYNC - Automatic Detect

Once the SP-016 and Layer N Smart Interface are connected to your computer, SYNC will automatically detect it and begin displaying temperature readings.

**Note** If you have successfully connected your SP-016 to SYNC and have readings appearing in SYNC, skip ahead to the section **4.3 Heat Flux Interface**.

### 4.2 Connecting to SYNC - Manual

If SYNC does not automatically detect your device, follow these instructions to manually connect it.

**Step 1:** Click on the  icon located on the top left of the SYNC interface.

**Step 2:** Proceed through the Add Device Wizard and click **End Device / Probe**.

### 4.2.1 Communication Interface

Set the communication parameters for the Layer N Smart Interface that you are connecting.

**Note** The connection type and parameters must be accurate for a proper connection to be established. Failure to accurately setup communication parameters may result in communication errors.

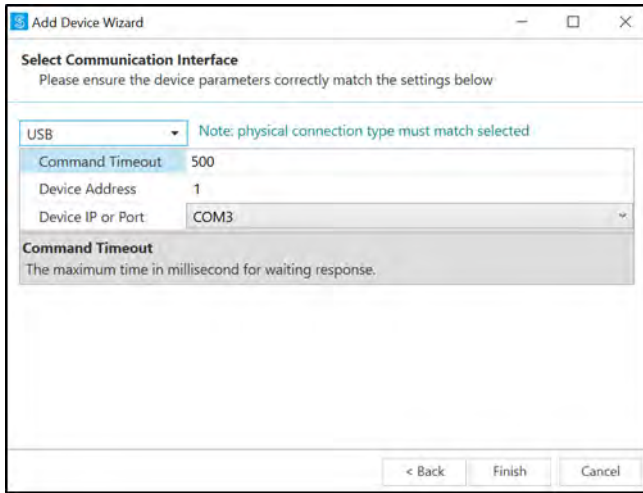

*USB Communication Interface*

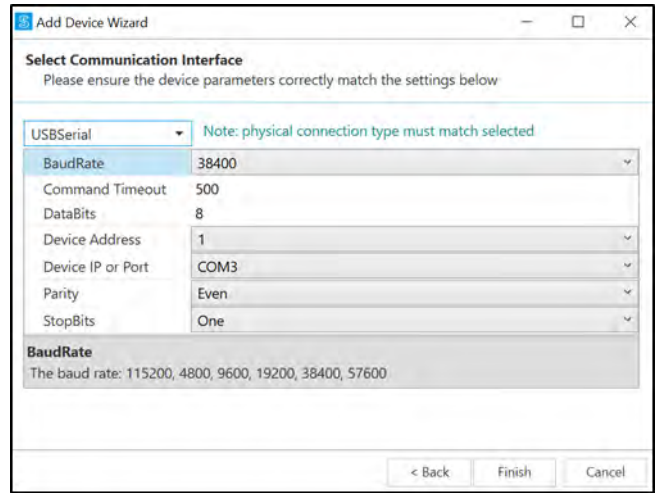

*USB Serial Communication Interface*

- **Connection Type:** Select the type of connection you have between your SP-016 and your computer.
- **Command Timeout:** The maximum time (in milliseconds) for a command to be completed before the command is aborted.

**Note** The default command timeout is 500 milliseconds. It is recommended that this section be left alone to avoid communication errors.

- **Device Address:** If your Smart Interface is part of a network, enter the Network Address here. The default network address is 1 for most devices. Please refer to the manual of your Smart Interface for more information.

**Note** The default Device Address is 1.

- **Device IP or Port:** The COM port number that your device is connected to on your computer.

**Important:** The following parameters should **NOT** be changed. These settings should **NOT** be changed unless the configuration has been done on the interface.

- **BaudRate:** Controls bits per second
- **DataBits:** The number of 'bits' in each character sent.
- **Parity:** A means of checking the correctness of a character by adding an extra 'bit' to the character and setting the value based on all the other bits in the character.
- **StopBits:** The number of 'bits' used to indicate the end of the character.

Once you have completed setting the communication parameters for your device, click **Finish**.



### 4.3 Heat Flux Interface

The SP-016 provides heat flux measurements in  $W/m^2$ . Heat Flux sensors, such as the OMEGA HFS-05, consist of a thermopile device and a temperature compensation (TempCo) measuring device, typically a T type thermocouple.

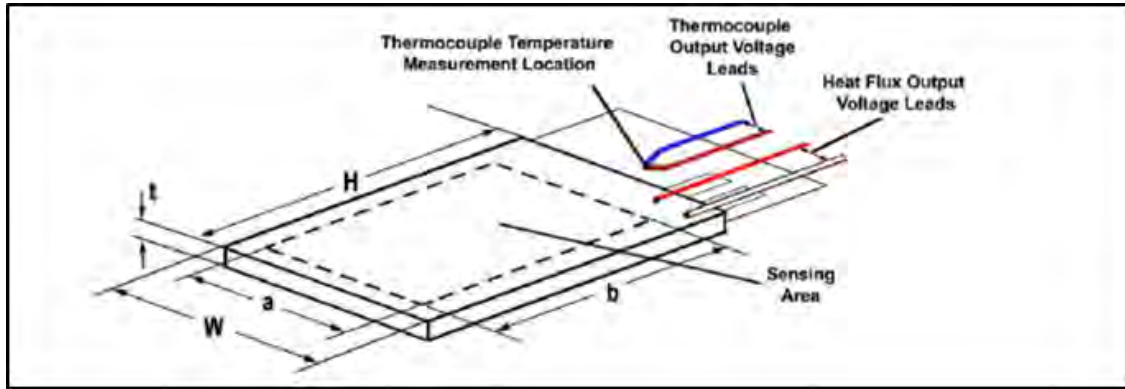

For OMEGA HFS products, the heat flux is calculated as:

$$q'' = V_{q''} / S_{@T_{OC}}$$

Where  $q''$  is the heat flux,  $V_{q''}$  is the measured voltage (in mV) and  $S_{@T_{OC}}$  is the temperature compensated sensor sensitivity, calculated as:

$$S_{@T_{OC}} = (TempCo_{Gain} * T_{OC} + TempCo_{Offset}) * S_{Calib}$$

$T_{OC}$  is the measured temperature from the T type thermocouple. From the HFS-05 datasheet:

	HFS-01 Value	Description
TempCo <sub>Gain</sub>	0.000334	Temperature Compensation Gain
TempCo <sub>Offset</sub>	0.917	Temperature Compensation Offset
S <sub>Calib</sub>	0.90	Calibrated Sensitivity (Provided on Calibration Sheet)

To configure these features, follow these steps:

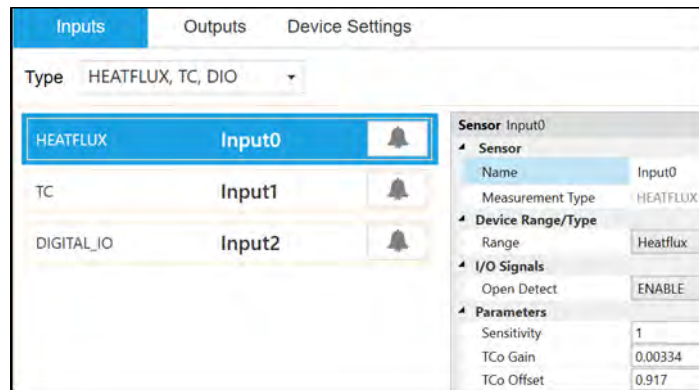

**Step 1:** Click the **Inputs** configuration tab on SYNC and choose **HEATFLUX** from the **Type** dropdown.

**Note:** Refer to your heat flux sensor data sheet for Sensitivity, Gain, and Offset values. Units for Sensitivity are measured in  $mV/(W/m^2)$ .

#### 4.4 Thermocouple Configuration

The SP-016 uses a thermocouple input for temperature compensation and provides interfaces to type J, K, T, E, N, R, S, B, and C thermocouples with the capability of enabling or disabling the open detect feature. To use these features, follow these steps:

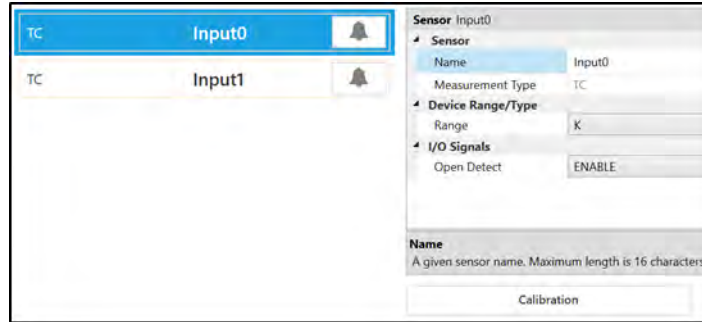

- Step 1:** Click the Inputs configuration tab on SYNC and choose an input type that includes TC from the Type dropdown.
- Step 2:** Click the input you wish to configure and select your thermocouple type from the Device Range/Type dropdown.
- Step 3:** Click the Open Detect drop down and choose to enable or disable it.

Type	Range	Accuracy
J	-210°C and 1200°C	0.4°C
K	160°C to 1372°C	0.4°C
T	190°C to 400°C	0.4°C
E	-220°C to 1000°C	0.4°C
N	-100°C to 1300°C	0.4°C
R	40°C to 1768°C	0.5°C
S	100°C to 1768°C	0.5°C
B	640°C to 1820°C	0.5°C
C	°C to 2320°C	0.4°C

## 4.5 Cold Junction Calibration

The SP-016 has automatic Cold Junction Compensation and is factory calibrated so that in most cases it needs no adjustment. However, for increased accuracy, Cold Junction Calibration can be performed as described below.

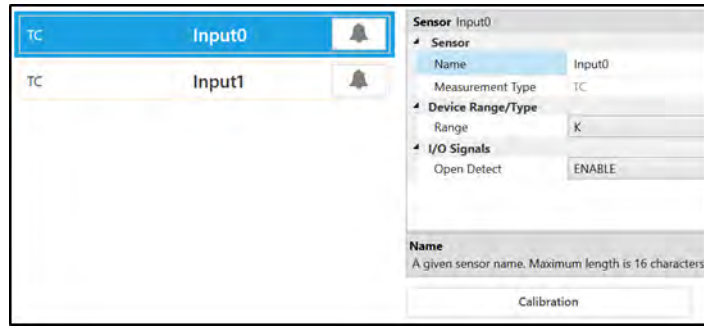

**Step 1:** Ensure your thermocouple has been configured in the previous section and click **Calibration** beneath the input interface.

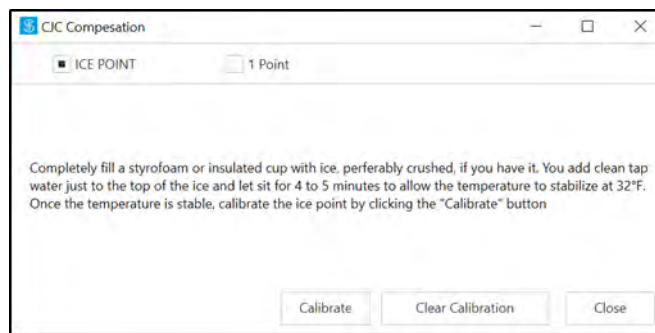

**Step 2:** Insert the heat flux sensor into 0°C reference and allow it to stabilize. Once it is stable in a 0°C (32°F) environment, click **Calibrate**.

## 4.6 Configurable Digital I/O

The Layer N SP-016 features 2 configurable digital I/O pins. These can be used for a myriad of applications including driving relays, physical alarms, or sensing dry contacts like door switches.

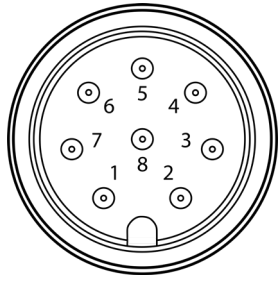

M12 8-Pin Connector

Pin	Name	Function
Pin 1	DIO 0	Discrete I/O Signal 0
Pin 2	INTR	Interrupt Signal
Pin 3	SCL	I2C Clock Signal
Pin 4	SDA	I2C Data Signal
Pin 5	Shield	Shield Ground
Pin 6	DIO 1	Discrete I/O Signal 1
Pin 7	GND	Power Ground
Pin 8	3.3VDD	Power Supply

### 4.6.1 Input Settings

To use a pin as an input, make sure it is set to Active Low (default) in the **Output Tab** in SYNC.

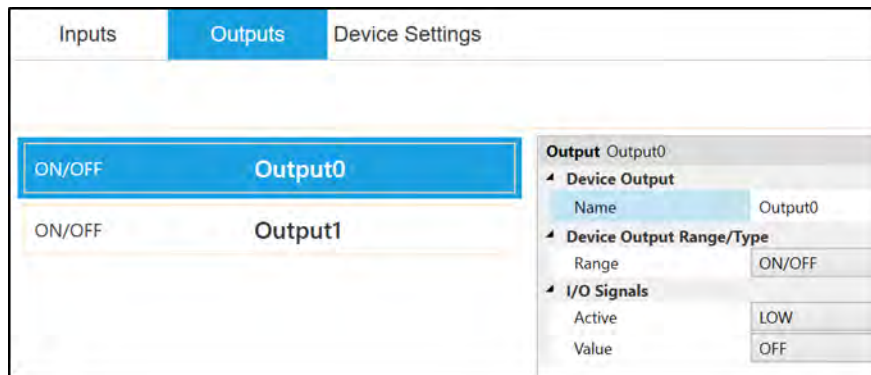

Each pin has an internal pull-up, but in order to save power, the internal pull-up is only active when the unit takes a reading. Refer to the following table to decode the input state.

Input 1	Input 0	Reading
Inactive	Inactive	0
Inactive	Active	1
Active	Inactive	2
Active	Active	3

### 4.6.2 Output Settings

To use a pin as an output, configure the outputs setting in the **Output Tab** and assign the output to an alarm using SYNC. For more information on how to set an alarm, refer to section **4.6.3 Setting Alarms**.

Output options are set in the Output Tab of SYNC. Each output can be configured as either Active High or Active Low. When configured as Active High the output conducts normally and becomes high impedance when activated. When configured as Active Low the Open Drain output is high impedance normally and will conduct when activated. It is recommended to change the input type to match the output type so that the output state will be correctly represented in logs.

#### 4.6.2.1 ON/OFF Functions

I/O signals can be changed between Active High, Active Low, and inactive.

Option	Value	Description
Active	LOW	When the output is inactive, it is in a high impedance state.
	HIGH	When the output is active, it is in a high impedance state.
Value	OFF	Set output inactive
	ON	Set output active

#### 4.6.2.2 Pulse-Width Modulation (PWM)

Pulse Width Modulation controls the amount of power given to a device by cycling the on/off phases of a digital signal. PWM consists of a duty cycle and frequency. The Duty Cycle measures the amount of time a signal is in the ON state as a percentage. The frequency controls how fast the PWM cycle is repeated. Users can select between the following settings:

Option	Value	Description
Rate	100 Hz	Signal has a constant 100 Hz frequency with 0-100% Duty Cycle
	10 Hz	Signal has a constant 10 Hz frequency with 0-100% Duty Cycle
	1 Hz	Signal has a constant 1 Hz frequency with 0-100% Duty Cycle
	0.1 Hz	Signal has a constant 0.1 Hz frequency with a 0-100% Duty Cycle
Signal Type	Active LOW	When the output is inactive, it is in a low impedance state
	Active HIGH	When the output is active, it is in a high impedance state.
Level	0-100%	Sets the duty cycle from 0-100%

#### 4.6.3 Setting Alarms

The screenshot shows the 'Define Alarm - Input0' configuration interface. It includes a sidebar with a list of alarms, where 'Alarm\_1' is selected. The main configuration area is divided into three sections: Condition, Action, and Recovery. The Condition section is configured with 'Sensor: Input0', 'High Threshold: 25', and 'Duration (s): 0'. The Action section is configured with 'Transmit Notification', 'Turn On: Output0', and 'Change: Transmission interval to 0 (s)'. The Recovery section is configured with 'Clear Alarm', 'After: 0', 'And: Reset', and 'Transmission interval'. At the bottom right, there are 'Save' and 'Cancel' buttons.

Alarms are set by clicking the  icon in SYNC on the desired input signal found in the **Inputs Configuration Tab**. Setup the threshold and alarm type in the **Condition** section and then select which output to turn on in the **Action** section. The alarm can be set to be latching or non-latching in the **Recovery** section.

#### 4.6.4 ON/OFF Control

To configure ON/OFF Control on a device, navigate to the **Output Configuration Tab** in SYNC and click on the  icon located to the right of the available outputs. Clicking the icon will open **Define ON/OFF Control** dialog box as seen below. Choose the input with the active alarm that you would like to control and set your preferred parameters.

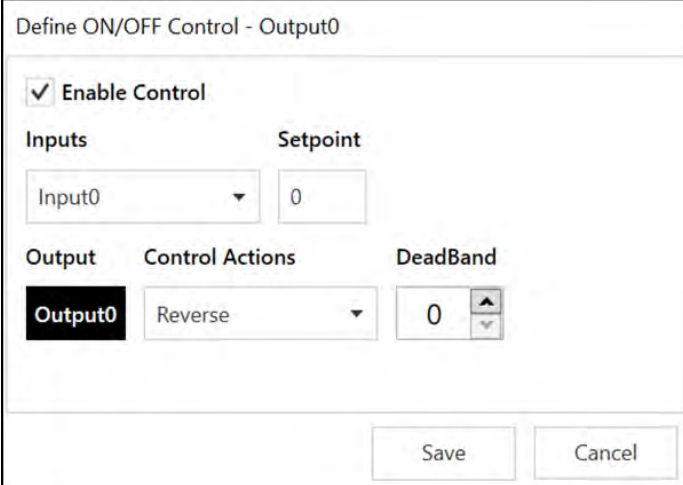

The dialog box is titled "Define ON/OFF Control - Output0". It contains the following fields and controls:

- Enable Control**
- Inputs**: A dropdown menu showing "Input0".
- Setpoint**: A text input field containing the value "0".
- Output**: A dropdown menu showing "Output0".
- Control Actions**: A dropdown menu showing "Reverse".
- DeadBand**: A spin button showing the value "0".

At the bottom right of the dialog box are two buttons: "Save" and "Cancel".

## 5 Appendix: SP-016 Registers

The following Appendix provides the registers and list index for the Layer N SP-016 Heat Flux Smart Probe. This information is intended to aid users who will be making configurations and adjustments to their Layer N SP-016 Heat Flux Smart Probe through the Command Line Interface or other custom interfaces.

Smart Probe devices share a common platform architecture that provides extensive monitoring and control capabilities through a set of platform generic registers. These registers may be accessed using I2C based commands directly to the Smart Probe devices or through a set of Modbus based registers when using Omega Interface devices. Refer to the *Smart Sensor Device Interface* manual for further information.

When powered on or after a device reset each Smart Sensor based device will enumerate 1 or more sensor instances which are described by the device specific Sensor Descriptors which include configuration options, measurement type, and units of measure for the corresponding sensor values. Additional sensor information is provided in sensor specific IPSO object descriptions which include extended measurement type, precision, and tracking of minimum/maximum readings.

Each enumerated Sensor has a Descriptor Base address location and a Sensor IPSO / Configuration structure address location based on the sensor mix selected.

Sensor	Descriptor Base	IPSO/Configuration	Enumerated Sensor	
0	0x0060 (0xf030)	0x08a8 (0xf454)	Heat Flux	
1	0x0068 (0xf034)	0x09a8 (0xf4d4)	TC	DIO (SP-016-1)
2	0x0070 (0xf048)	0x0aa8 (0xf554)	DIO (SP-016-1)	
3	0x0078 (0xf03c)	0x0ba8 (0xf5d4)	Not Used	

### 5.1 Heat Flux Input Descriptor

The SP-016 configures the sensors based on the factory device list and user specified list index.

The Sensor Configuration and Sensor Device fields may be written to provide control of the overall function of the channel and the signal types used.

Offset	Name	Value	Description
0x00	Measurement Type	0x35	Heat Flux (W/m <sup>2</sup> )
0x01	Data Type/Format	0x26	Float, Factory Calibration enabled
0x02	Configuration	0x??	Sensor Range/Type (not used)
0x03	Sensor Device	0x??	Sensor IO Configuration
0x04..0x08	UOMR	"W/m2"	Units of measure

#### 5.1.1 Heat Flux Measurement Types

The interface provides a measurement of the heat flux in W/m<sup>2</sup>.

Sensor Type	SI Derived Units	Measurement
0x35	W/m2	Watts per square meter

#### 5.1.2 Heat Flux Input Data Type/Format

The SP-016 supports extended configuration and provides factory calibration. All data values are returned as 32-bit floating point values.

Heat Flux Input Data Type/Format							
7	6	5	4	3	2	1	0
Smart Sensor	Writable	Factory Calibrate	Reserved	Data Type			
0	0	?	0	6 == Floating point			

### 5.1.2.1 Data Type

The 4-bit Data Type field determines the type of data of the specific sensor.

### 5.1.2.2 Factory Calibrate

Factory calibration is used on the SP-016 process inputs. Clearing this bit will disable the factory calibration values.

### 5.1.2.3 Sensor Writeable

The writable bit is cleared, indicating that the sensor values may not be overwritten.

### 5.1.2.4 Smart Sensor

Refer to the Smart Sensor Device Interface documentation.

## 5.1.3 Heat Flux Input Configuration

Digital Configuration							
7	6	5	4	3	2	1	0
Available	Assigned	Apply Scaling	Lock	Sensor Range / Type			
0	*	?	?	(Internal Use Only)			

### 5.1.3.1 Apply Scaling

For more information on Gain and Offset, refer to the Smart Sensor Manual. If set, the user-defined Offset and Gain values will be used to adjust the sensor reading:

$$\text{Result} = (\text{Raw Reading} * \text{Gain}) + \text{Offset}$$

### 5.1.3.2 Lock

If set, the user-specified units of measure string (4-character maximum) will be used in place of the default units of measure.

### 5.1.3.3 Assigned

Refer to the *Smart Sensor Device Interface* documentation.

### 5.1.3.4 Available

Refer to the *Smart Sensor Device Interface* documentation.

## 5.1.4 Heat Flux Sensor I/O Byte

For Heat Flux I/O types the Device Byte field determines the signal types for each of the channel bits.

Heat Flux I/O Byte								
7	6	5	4		3	2	1	0
0	0	0	Open Circuit Detect		0	0	0	0
			0	Disabled				
			1	Enabled				



### 5.1.5 Heat Flux Sensor Parameters

The SP-016 provides 3 sensor parameters related to the Heat Flux Sensor (Sensor 0). These values may be updated based on the specific heat flux sensor being used.

Parameter	Name	Range	Factory Reset	Description
0	Sensitivity	0 - 100.0	1.0	Sensitivity
1	TempCo Gain	0 - 1.0	0.00334	Temperature Gain factor used in $S_{@T} = \text{TempCo}_{\text{Gain}} * T_{\text{meas}} + \text{TempCo}_{\text{Offset}}$
2	TempCo Offset	0 - 1.0	0.917	Temperature Gain factor used in $S_{@T} = \text{TempCo}_{\text{Gain}} * T_{\text{meas}} + \text{TempCo}_{\text{Offset}}$

### 5.1.6 Heat Flux User Calibration Parameters

The SP-016 provides a single User Calibration register that may be set while the device is in the User Calibrate mode and is 'added' to the calculated value during normal operation, providing a fixed offset to the calculated Heat Flux value. During the User Calibration process, the actual (independently measured) Heat Flux value (Target Value) may be entered and the SP-016 will save the difference between the current measured value and the Target Value as the Calibration value. The User Calibration may be used when the sensor is measuring 0 heat flux to provide a simple method to correct for minor offset errors.

**Note:** The device must be put into the 'Calibration' mode to access the User Calibration parameters.

User Calibration Parameter	Name	Range	Factory Reset	Description
0	Heatflux	+/- 1000.0	0	Adjusts the heat flux value to allow the measured heat flux to equal the target heatflux

### 5.1.7 IPSO Digital Input Sensor Definition

The IPSO Heat Flux definition provides signal range, measured min/max values, IPSO object type information

Offset	Name	Value	Description
0x00	Sensor Type	33130	Heat Flux W/m <sup>2</sup> (OMEGA Defined)
0x02	Precision	1	Provides reading of xxx
0x04	Sensor Trigger	??	See section Sensor Trigger Function
0x08	Min Measured	??	Minimum reading since the last reset
0x0c	Max Measured	??	Maximum reading since the last reset
0x10	Min Range	-150000	Minimum reading
0x14	Max Range	+150000	Maximum reading

### 5.1.7.1 Sensor Trigger Function

The Sensor Trigger function is used to reset the IPSO min/max values as well as controlling the Calibration process.

Sensor Trigger Function							
7	6	5	4	3	2	1	0
0	0	0	0	0	0	0	Reset Min/Max
15	14	13	12	11	10	9	8
0	0	Calibration Reset	Calibration Status	Calibration Mode	Capture High	Capture Low	Calibration Start

Setting the Reset Min/Max bit to 1 will reset the Min/Max values recorded by the IPSO process.

The Calibration mode is entered by writing a 1 to the Calibration Mode bit. While in the calibration mode the calibration registers may be accessed and the Calibration Start may be set. When the Calibration Start bit is set the Calibration Status bit will remain set until the calibration process is complete.

Setting the Calibration Reset bit will clear the calculated Offset value.

## 5.2 Thermocouple Descriptor

The Thermocouple Input interface provides interfaces to type J, K, T, E, N, R, S, B, and C thermocouples. The default T type is typically used on Heat Flux sensor devices (HFS-05). The Sensor Configuration and Sensor Device fields may be written to provide control of the overall function of the channel and the thermocouple types used.

Offset	Name	Value	Description
0x00	Measurement Type	0x20	Temperature (°C)
0x01	Data Type/Format	0x26	Float, Factory Calibration enabled
0x02	Configuration	0x4?	Determines Thermocouple type
0x03	Sensor Device	0x??	Determines connection type
0x04..0x08	UOMR	“°C”	Units of measure

### 5.2.1 Thermocouple Measurement Types

The Thermocouple interface provides a measurement of Temperature in °C.

Sensor Type	SI Derived Units	Measurement
0x20	°C	Temperature

### 5.2.2 Thermocouple Input Data Type/Format

The SP-016 supports extended configuration and provides factory calibration. All data values are returned as 32-bit floating point values.

Thermocouple Input Data Type/Format							
7	6	5	4	3	2	1	0
Smart Sensor	Sensor Writable	Factory Calibrate	Reserved	Data Type			
0	0	?	0	0x06 == FLOAT			

#### 5.2.2.1 Data Type

The 4-bit Data Type field determines the type of data of the specific sensor.

#### 5.2.2.2 Factory Calibrate

Factory calibration is used on the SP-016 process inputs. Clearing this bit will disable the factory calibration values.

#### 5.2.2.3 Sensor Writable

The writable bit is cleared, indicating that the sensor values may not be overwritten.

#### 5.2.2.4 Smart Sensor

Refer to the Smart Sensor Device Interface documentation.

### 5.2.3 Thermocouple Input Configuration

Thermocouple Input Configuration							
7	6	5	4	3	2	1	0
Available	Assigned	Apply Scaling	Lock	Sensor Type (Range)			
0	*	?	?	See Below			

#### 5.2.3.1 Sensor Type / Range

Sensor Type	Sensor Input Type (Range)	Measurement Type
0x00	Type J	0x20 Temperature (oC)
0x01	Type K	0x20 Temperature (oC)
0x02	Type T	0x20 Temperature (oC)
0x03	Type E	0x20 Temperature (oC)
0x04	Type N	0x20 Temperature (oC)
0x05	Reserved	
0x06	Type R	0x20 Temperature (oC)
0x07	Type S	0x20 Temperature (oC)
0x08	Type B	0x20 Temperature (oC)
0x09	Type C	0x20 Temperature (oC)

### 5.2.3.2 Apply Scaling

For more information on Gain and Offset, refer to the Smart Sensor Manual. If set, the user-defined Offset and Gain values will be used to adjust the sensor reading:

$$\text{Result} = (\text{Raw Reading} * \text{Gain}) + \text{Offset}$$

### 5.2.3.3 Lock

If set, the user-specified units of measure string (4-character maximum) will be used in place of the default units of measure.

### 5.2.3.4 Assigned

Refer to the *Smart Sensor Device Interface* documentation.

### 5.2.3.5 Available

Refer to the *Smart Sensor Device Interface* documentation.

## 5.2.4 Thermocouple Sensor Device Byte

The Sensor Device byte determines whether the Open Circuit detection is enabled.

Thermocouple Sensor Device Byte								
7	6	5	4		3	2	1	0
0	0	0	Open Circuit Detect		0	0	0	0
			0	Disabled				
			1	Enabled				

## 5.2.5 Thermocouple User Calibration Parameter

The SP-016 provides a Thermocouple User Calibration register that may be set while the device is in the User Calibrate mode and that is used to adjust the Cold Junction Compensation (CJC) value during normal operation.

During the User Calibration process, the actual (independently measured) Temperature value (Target Value) may be entered and the SP-016 will the difference between the current measured temperature and the Target temperature to adjust the CJC value. The User Calibration may be used when the thermocouple is measuring 0 degrees (Ice Point calibration) to provide a simple method to correct for minor offset errors.

**Note:** The device must be put into the 'Calibration' mode to access the User Calibration parameters.

User Calibration Parameter	Name	Range	Factory Reset	Description
0	CJC Calibration	± 1000.0	0.0	Adjusts the Cold Junction Compensation value to allow the measured temperature to equal the target temperature.

### 5.2.6 IPSO Thermocouple Temperature Sensor Definition

The Thermocouple sensor IPSO definition provides signal range, measured min/max values, IPSO object type information. The Range information is Thermocouple Type dependent.

Offset	Name	Value	Description																														
0x00	Sensor Type	3303	Temperature (oC)																														
0x02	Precision	1	Provides reading of xxx.x																														
0x04	Reset Min/Max	??	Write any value to force a reset of min/max																														
0x08	Min Measured	??	Minimum reading since the last reset																														
0x0c	Max Measured	??	Maximum reading since the last reset																														
0x10	Min Range	??	<table border="1"> <thead> <tr> <th>Type</th> <th>Min Range</th> <th>Max Range</th> </tr> </thead> <tbody> <tr> <td>J</td> <td>-210</td> <td>1200</td> </tr> <tr> <td>K</td> <td>-160</td> <td>1272</td> </tr> <tr> <td><b>T</b></td> <td><b>-190</b></td> <td><b>400</b></td> </tr> <tr> <td>E</td> <td>-220</td> <td>1000</td> </tr> <tr> <td>N</td> <td>-100</td> <td>1300</td> </tr> <tr> <td>R</td> <td>40</td> <td>1788</td> </tr> <tr> <td>S</td> <td>100</td> <td>1768</td> </tr> <tr> <td>B</td> <td>640</td> <td>1820</td> </tr> <tr> <td>C</td> <td>0</td> <td>2320</td> </tr> </tbody> </table>	Type	Min Range	Max Range	J	-210	1200	K	-160	1272	<b>T</b>	<b>-190</b>	<b>400</b>	E	-220	1000	N	-100	1300	R	40	1788	S	100	1768	B	640	1820	C	0	2320
			Type	Min Range	Max Range																												
J	-210		1200																														
K	-160		1272																														
<b>T</b>	<b>-190</b>		<b>400</b>																														
E	-220		1000																														
N	-100		1300																														
R	40		1788																														
S	100		1768																														
B	640		1820																														
C	0	2320																															
0x14	Max Range																																

#### 5.2.6.1 Sensor Trigger Function

The Sensor Trigger function is used to reset the IPSO min/max values as well as control the ICE Point / Single-Point Calibration process.

Sensor Trigger Function							
7	6	5	4	3	2	1	0
0	0	0	0	0	0	0	Reset Min/Max
15	14	13	12	11	10	9	8
0	0	Calibration Reset	Calibration Status	Calibration Mode	0	Capture Low	Calibration Start

The Calibration mode is entered by writing a 1 to the Calibration Mode bit. While in the calibration mode the calibration registers may be accessed, the Capture may be used to capture the real-time value and the Calibration Start may be set.

When the Calibration Start bit is set the Calibration Status bit will remain set until the calibration process is complete. Setting the Calibration Reset bit will clear the calculated Offset values.

### 5.3 Digital Input / Output Descriptor

The DIO Interface provides 2 digital inputs that are hardwired to the Digital outputs. These may be used to detect the state of external switches (output off) or to monitor the state of the outputs.

Offset	Name	Value	Description
0x00	Sensor Type	0x18	Digital Type (Bit mapped)
0x01	Data Type/Format	0x46	Configurable, Float type
0x02	Configuration	0x23	Scaling applied, Bits 0 and 1 enabled
0x03	Sensor Device	0x0f	DIN bits enabled/inverted
0x04..0x08	UOMR	"DIN"	Units of measure

#### 5.3.1 DIO Sensor Type

The interface provides a bit mapped input of the 2 digital signal lines.

Sensor Type	SI Derived Units	Measurement
0x18	DIN	Bit mapped digital inputs

#### 5.3.2 DIO Data Type/Format

DIO Data Type							
7	6	5	4	3	2	1	0
Smart Sensor	Sensor Writable	Factory Calibrate	Reserved	Data Type			
0	0	0	0	6 == Floating point			

**Note** Please refer to the Smart Sensor Interface Technical Guide for more information regarding this descriptor.

##### 5.3.2.1 Data Type

The 4-bit Data Type field determines the type of date of the specific sensor.

##### 5.3.2.2 Factory Calibrate

The Factory Calibrate bit is not used for DIO types.

##### 5.3.2.3 Sensor Writable

If the Sensor Writable bit is set the sensor value may be overwritten with a preset value. This capability is useful in sensors such as up/down counters, where a preset, or possibly a zero value must be written to the sensor value.

##### 5.3.2.4 Smart Sensor

Refer to the *Smart Sensor Device Interface* documentation.

#### 5.3.3 DIO Input Configuration

DIO Input Configuration							
7	6	5	4	3	2	1	0
Available	Assigned	Apply Scaling	Lock	Sub Channel Selection			
0	0	1	?	0x03 == bits 0 and 1			

### 5.3.3.1 Lock

If set, the user-specified units of measure string (4-character maximum) will be used in place of the default **DIN**.

### 5.3.3.2 Apply Scaling

If set, the user-defined Offset and Gain values will be used to adjust the sensor reading. For more information on Gain and Offset, refer to the Smart Sensor Manual.

$$\text{Result} = (\text{Raw Reading} * \text{Gain}) + \text{Offset}$$

### 5.3.3.3 Assigned

The Assigned bit will always read as 0. Refer to the *Smart Sensor Device Interface* documentation for further information.

### 5.3.3.4 Available

The Available bit will always read as 0. Refer to the *Smart Sensor Device Interface* documentation for further information.

## 5.3.4 DIO Device Configuration

The DIO Device Configuration allows enabling each of the 2 input bits and selecting whether the input is active HIGH or active LOW. If the Invert Bit is set the signal will be Active Low.

DIO Device Configuration							
7	6	5	4	3	2	1	0
Reserved				DIN 1		DIN 0	
0	0	0	0	ENABLE	INVERT	ENABLE	INVERT
				1	1	1	1

### 5.3.4.1 Invert

If the Invert bit is set the input is active LOW.

### 5.3.4.2 Enable

If the Enable bit is set the input is enabled.

## 5.3.5 DIO IPSO Definition

The DIO input IPSO definition provides signal range, measured min/max values, IPSO object type information.

Offset	Name	Value	Description
0x00	Sensor Type	3349	Bit Mapped Digital
0x02	Precision	0	Provides reading of xxx
0x04	Sensor Trigger Function	??	See section Sensor Trigger Function
0x08	Min Measured	??	Minimum reading since last reset
0x0c	Max Measured	??	Maximum reading since last reset
0x10	Min Range	0	Minimum reading
0x14	Max Range	3	Maximum reading

### 5.3.5.1 Sensor Trigger Function

The Sensor Trigger function is used to reset the IPSO min/max values as well as to control the Calibration process.

Sensor Trigger Function							
7	6	5	4	3	2	1	0
0	0	0	0	0	0	0	Reset Min/Max
15	14	13	12	11	10	9	8
0	0	0	0	0	0	0	0

Setting the Reset Min/Max bit to 1 will reset the Min/Max values recorded by the IPSO process.

No User Calibration process is supported on the DIO inputs and all bits should be written as 0.

### 5.3.6 DIO Input Circuitry

The DIO input circuitry shares the output circuitry. The internal processor drives the Output Control signal to turn on the output driver which will force the output LOW. When the state of the DIO input signal is to be read the processor applies  $3.0 V_{DC}$  to the Input Bias signal and reads the level detected at the Input Sense. If the output is inactive, an external signal may be used to force the input level LOW. A diode protects external positive voltages, allowing the Output driver to activate loads greater than the internal  $3.3 V_{DC}$ .

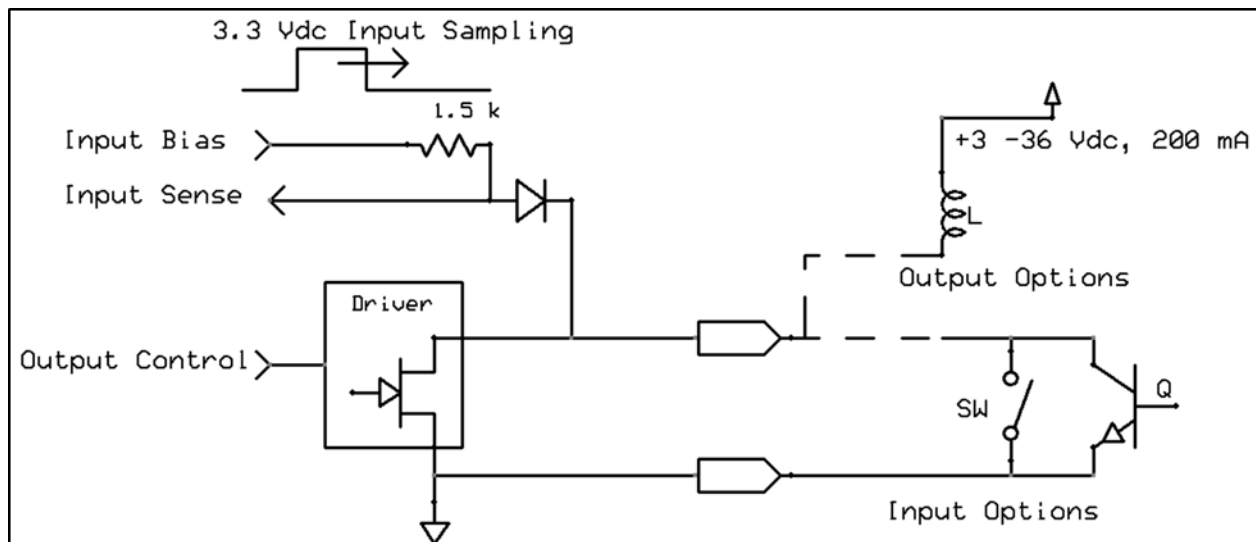



## 5.4 Outputs

Two output signals are available which may be configured for ON/OFF or PWM outputs through the Output Configuration registers 0x0124 and 0x0126.

**Note** The Output Drive Type (Open Drain, inverting driver) is fixed.

Outputs												
7	6		5	4		3	2	1		0		
Output Driver				Active State				PWM Rate				
Open Drain, Inverting Driver	1	1		LOW	0			100 Hz	0	0		
				HIGH	1			10 Hz	0	1		
								1 Hz	1	0		
								0.1 Hz	1	1		
15	14		13	12		11	10	9		8		
								Output Type				
								Null	0	0	0	0
								ON/OFF	0	0	0	1
								PWM	0	0	1	0
								Reserved	x	1	x	x
									1	x	x	x

### 5.4.1 PWM Rate

The SP-016 probe outputs support the following PWM frequencies:

PWM Rate	Name	Description
0	100 Hz	PWM signal has a constant 100 Hertz frequency (10 msec repetition rate) with 0 – 100 % duty cycle
1	10 Hz	PWM signal has a constant 10 Hertz frequency (100 msec repetition rate) with 0 – 100 % duty cycle
2	1 Hz	PWM signal has a constant 1 Hertz frequency (1 second repetition rate) with 0 – 100 % duty cycle
3	0.1 Hz	PWM signal has constant 0.1 Hertz frequency (10 second repetition rate) with 0 – 100 % duty cycle

### 5.4.2 Active State

The SP-016 probe outputs may be configured as Active HIGH or Active LOW. When set to 1 (Active HIGH), the output will be high impedance when active. When set to 0 (Active LOW), the output will be low impedance when active. The Factory reset value is 0.

### 5.4.3 Output Drive

The Output Drive is permanently set to 3, indicating that the output is configured as an Open Drain driver, allowing the DIN signal to override and read back the state of the output signal.

### 5.4.4 Output Type

The SP-016 probe supports NULL (0), ON/OFF (1) or PWM (2) outputs. When set to NULL the output signal will be left in a high impedance state. When set to ON/OFF the Rate information has no effect.

## 6 Specifications

### INPUT POWER

**Voltage:** 2.8 V<sub>DC</sub> - 3.3 V<sub>DC</sub>

### DIO DIGITAL INPUTS

$V_{inHighThreshold} = 2.2 V_{MAX}$

$V_{inLowThreshold} = 0.3 V_{MIN}$

$V_{inMAX} = 30 V_{DC}$

### DIO DIGITAL OUTPUTS

2x Open Drain 100 mA max

$V_{MAX} = 30 V_{DC}$

### ACCURACY

Heat Flux Input		
Type	Range	Accuracy
mV Input	±60mV	±0.02% or ±4uV

**Stability over Temperature:** ±1uV/C

Temperature Compensation Input		
Type	Range	Accuracy
J	-210°C and 1200°C	0.4°C
K	160°C to 1372°C	0.4°C
T	190°C to 400°C	0.4°C
E	-220°C to 1000°C	0.4°C
N	-100°C to 1300°C	0.4°C
R	40°C to 1768°C	0.5°C
S	100°C to 1768°C	0.5°C
B	640°C to 1820°C	0.5°C
C	°C to 2320°C	0.4°C

**Temperature Stability @ 25°C:** Thermocouple 0.04 °C/°C

### ENVIRONMENTAL

**Operating Temperature:** -40 to 85°C (-40 to 185°F)

**Rating:** IP67 when mated

### MECHANICAL

**Dimensions:** 22.1 mm W x 96.7 mm L (0.87" x 3.80") not including mounting tabs

### GENERAL

**Agency Approvals:** CE, EMC 2014/30/EU, LVD 2014/35/EU

**Compatibility:** Compatible with OEG, SYNC configuration software, Layer N Cloud, and Modbus Networks

## WARRANTY/DISCLAIMER

OMEGA ENGINEERING, INC. warrants this unit to be free of defects in materials and workmanship for a period of **13 months** from date of purchase. OMEGA's WARRANTY adds an additional one (1) month grace period to the normal **one (1) year product warranty** to cover handling and shipping time. This ensures that OMEGA's customers receive maximum coverage on each product.

If the unit malfunctions, it must be returned to the factory for evaluation. OMEGA's Customer Service Department will issue an Authorized Return (AR) number immediately upon phone or written request. Upon examination by OMEGA, if the unit is found to be defective, it will be repaired or replaced at no charge. OMEGA's WARRANTY does not apply to defects resulting from any action of the purchaser, including but not limited to mishandling, improper interfacing, operation outside of design limits, improper repair, or unauthorized modification. This WARRANTY is VOID if the unit shows evidence of having been tampered with or shows evidence of having been damaged as a result of excessive corrosion; or current, heat, moisture or vibration; improper specification; misapplication; misuse or other operating conditions outside of OMEGA's control. Components in which wear is not warranted, include but are not limited to contact points, fuses, and triacs.

**OMEGA is pleased to offer suggestions on the use of its various products. However, OMEGA neither assumes responsibility for any omissions or errors nor assumes liability for any damages that result from the use of its products in accordance with information provided by OMEGA, either verbal or written. OMEGA warrants only that the parts manufactured by the company will be as specified and free of defects. OMEGA MAKES NO OTHER WARRANTIES OR REPRESENTATIONS OF ANY KIND WHATSOEVER, EXPRESSED OR IMPLIED, EXCEPT THAT OF TITLE, AND ALL IMPLIED WARRANTIES INCLUDING ANY WARRANTY OF MERCHANTABILITY AND FITNESS FOR A PARTICULAR PURPOSE ARE HEREBY DISCLAIMED. LIMITATION OF LIABILITY: The remedies of purchaser set forth herein are exclusive, and the total liability of OMEGA with respect to this order, whether based on contract, warranty, negligence, indemnification, strict liability or otherwise, shall not exceed the purchase price of the component upon which liability is based. In no event shall OMEGA be liable for consequential, incidental or special damages.**

CONDITIONS: Equipment sold by OMEGA is not intended to be used, nor shall it be used: (1) as a "Basic Component" under 10 CFR 21 (NRC), used in or with any nuclear installation or activity; or (2) in medical applications or used on humans. Should any Product(s) be used in or with any nuclear installation or activity, medical application, used on humans, or misused in any way, OMEGA assumes no responsibility as set forth in our basic WARRANTY/DISCLAIMER language, and, additionally, purchaser will indemnify OMEGA and hold OMEGA harmless from any liability or damage whatsoever arising out of the use of the Product(s) in such a manner.

## RETURN REQUESTS/INQUIRIES

Direct all warranty and repair requests/inquiries to the OMEGA Customer Service Department. BEFORE RETURNING ANY PRODUCT(S) TO OMEGA, PURCHASER MUST OBTAIN AN AUTHORIZED RETURN (AR) NUMBER FROM OMEGA'S CUSTOMER SERVICE DEPARTMENT (IN ORDER TO AVOID PROCESSING DELAYS). The assigned AR number should then be marked on the outside of the return package and on any correspondence.

The purchaser is responsible for shipping charges, freight, insurance and proper packaging to prevent breakage in transit.

FOR **WARRANTY** RETURNS, please have the following information available BEFORE contacting OMEGA:

1. Purchase Order number under which the product was PURCHASED,
2. Model and serial number of the product under warranty, and
3. Repair instructions and/or specific problems relative to the product.

FOR **NON-WARRANTY** REPAIRS, consult OMEGA for current repair charges. Have the following information available BEFORE contacting OMEGA:

1. Purchase Order number to cover the COST of the repair,
2. Model and serial number of the product, and
3. Repair instructions and/or specific problems relative to the product.

OMEGA's policy is to make running changes, not model changes, whenever an improvement is possible. This affords our customers the latest in technology and engineering.

OMEGA is a trademark of OMEGA ENGINEERING, INC.

© Copyright 2019 OMEGA ENGINEERING, INC. All rights reserved. This document may not be copied, photocopied, reproduced, translated, or reduced to any electronic medium or machine-readable form, in whole or in part, without the prior written consent of OMEGA ENGINEERING, INC.

# Where Do I Find Everything I Need for Process Measurement and Control? **OMEGA...Of Course!** *Shop online at [omega.com](http://omega.com)*

## **TEMPERATURE**

- Thermocouple, RTD & Thermistor Probes, Connectors, Panels & Assemblies
- Wire: Thermocouple, RTD & Thermistor
- Calibrators & Ice Point References
- Recorders, Controllers & Process Monitors
- Infrared Pyrometers

## **PRESSURE, STRAIN AND FORCE**

- Transducers & Strain Gages
- Load Cells & Pressure Gages
- Displacement Transducers
- Instrumentation & Accessories

## **FLOW/LEVEL**

- Rotameters, Gas Mass Flowmeters & Flow Computers
- Air Velocity Indicators
- Turbine/Paddlewheel Systems
- Totalizers & Batch Controllers

## **pH/CONDUCTIVITY**

- pH Electrodes, Testers & Accessories
- Benchtop/Laboratory Meters
- Controllers, Calibrators, Simulators & Pumps
- Industrial pH & Conductivity Equipment

## **DATA ACQUISITION**

- Communications-Based Acquisition Systems
- Data Logging Systems
- Wireless Sensors, Transmitters, & Receivers
- Signal Conditioners
- Data Acquisition Software

## **HEATERS**

- Heating Cable
- Cartridge & Strip Heaters
- Immersion & Band Heaters
- Flexible Heaters
- Laboratory Heaters

## **ENVIRONMENTAL MONITORING AND CONTROL**

- Metering & Control Instrumentation
- Refractometers
- Pumps & Tubing
- Air, Soil & Water Monitors
- Industrial Water & Wastewater Treatment
- pH, Conductivity & Dissolved Oxygen Instruments